

Orbitrap ID-X Tribrid mass spectrometer

Transforming small molecule identification and characterization

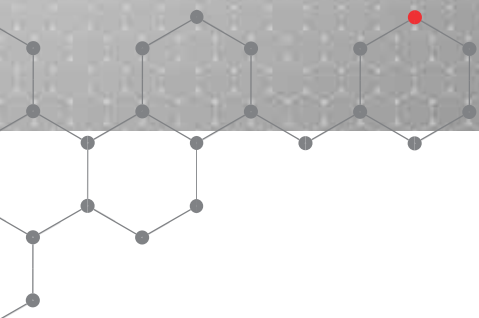



A leap ahead for small molecule analyses

Acquisition and interpretation of mass spectra to characterize and identify small-molecule unknowns is a formidable task. Sample complexities, background interferences, compound structural diversity, and the lack of robust data processing tools can make it difficult to set up analytical methods and interpret data. Overcoming these bottlenecks requires advances in both data acquisition and computational tools.

Equipped with the novel, automated AcquireX intelligent data acquisition workflow including various characterization capabilities using intelligent MSⁿ and a multitude of mass spectral data processing tools, the Thermo Scientific™ Orbitrap ID-X™ Tribrid™ mass spectrometer can help you extract meaningful data faster and with the highest confidence.

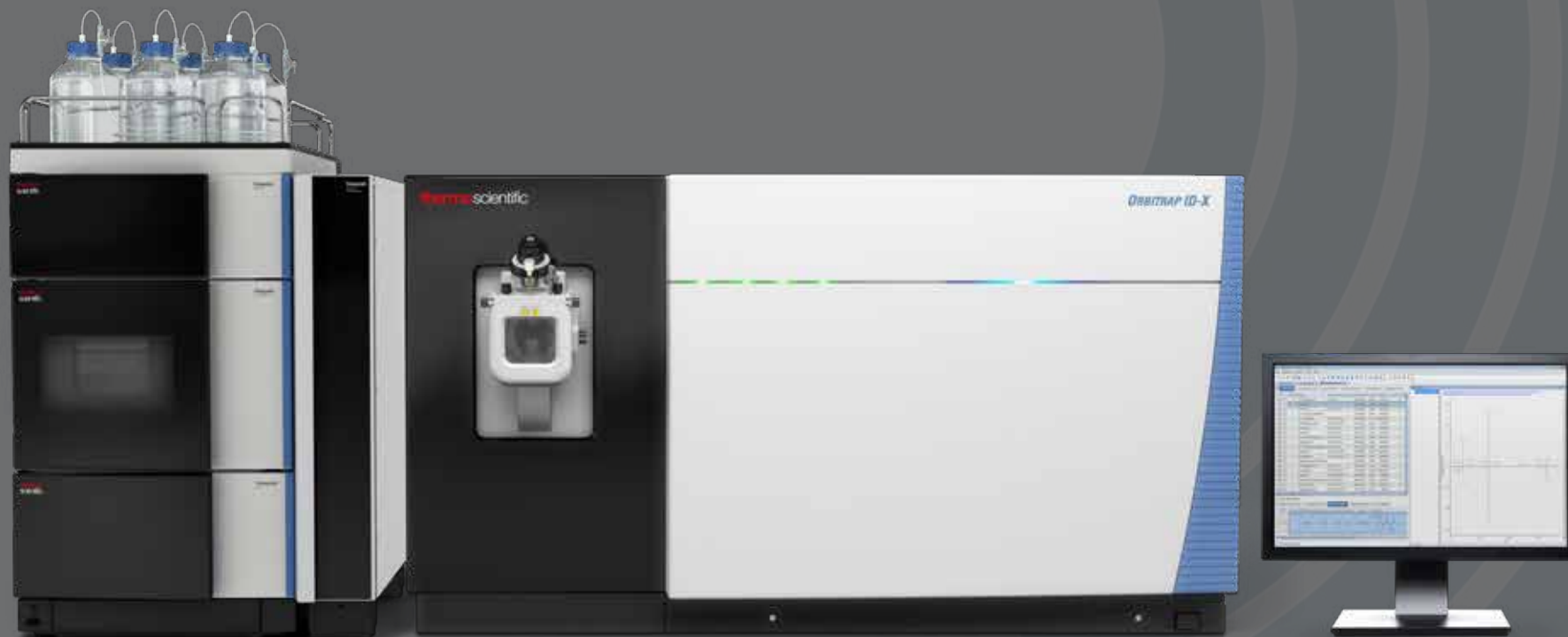

Break your bottlenecks with intelligence and technology— from acquisition to analysis

Go beyond today's small molecule analyses and capture more low-abundance analytes in complex samples using intelligent automation and streamlined mass spectral processing, elucidation, and identification software.

- **Focus on science, not instrument setup**

The unique combination of Thermo Scientific™ Tribrid™ mass spectrometer architecture, built-in method editor templates, and ready-to-use experimental parameters enable you to analyze complex samples without extensive expertise or effort. The easy-to-use method templates support a variety of small molecule applications to define data acquisition using combinations of high-resolution accurate-mass (HRAM) and ion trap mass analyzers, and MSⁿ fragmentation using either collision-induced dissociation (CID) or high-energy collision dissociation (HCD) techniques.

- **Collect more meaningful data, not just more data**

MS and MSⁿ data acquisition methods for compound identification have been limited by the relative abundances of compounds of interest relative to the background and/or sample matrices. Duty cycle is often wasted triggering on background. Manually excluding background and creating inclusion lists for relevant features is too laborious. A breakthrough in intelligent automation, AcquireX, increases profiling efficiency by automating inclusion/exclusion list creation for MSⁿ data acquisition so you find more compounds with distinguishable fragmentation patterns.

- **Meet data analysis requirements for speed, simplicity, and flexibility**

High-quality MSⁿ data generated by the Orbitrap ID-X Tribrid mass spectrometer reduces compound identification bottlenecks. Confidently identify knowns and unknowns, and elucidate structures of unknowns using spectral library searching, MSⁿ mass spectral tree annotation, *in silico* fragmentation, and precursor ion fingerprinting. High-certainty identification and characterization of small molecules is now remarkably fast.

- **Demystifying unknown annotation using high-quality MSⁿ data**

Confidently identify known unknowns and elucidate structures of unknown unknowns with novel spectral prediction tools and processing routines. New data processing methods leverage custom library searching, *in silico* fragmentation modeling, and precursor ion fingerprinting to associate high-quality MSⁿ data from unknown precursors with compound structures.

Building on proven Tribrid architecture

The Orbitrap ID-X Tribrid mass spectrometer is based on the proven and trusted tribrid architecture that combines the best of quadrupole ion trap and HRAM Thermo Scientific™ Orbitrap™ mass analyzer technology for acquisition of the richest MSⁿ data for every sample run. Dual fragmentation techniques—CID and HCD—are available at any stage of MSⁿ, with subsequent mass analysis in either the ion trap or ultra-high-resolution Orbitrap mass analyzer.

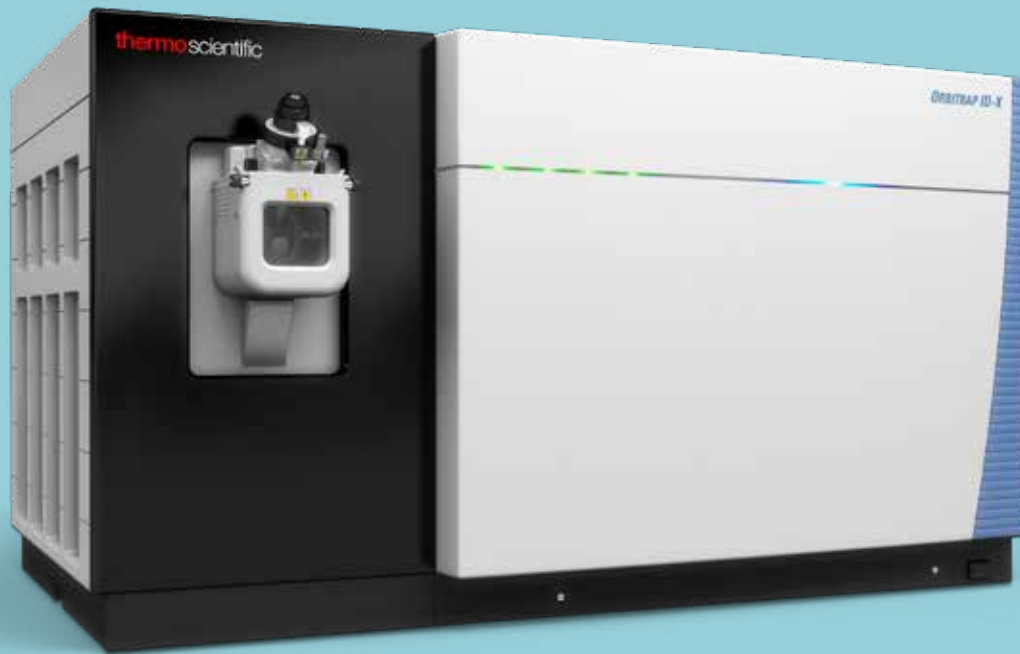

Active Beam Guide

Prevents neutrals and high-velocity clusters from entering the mass resolving quadrupole

Optional EASY-IC Ion Source

Generates internal calibrant ions for real-time mass calibration

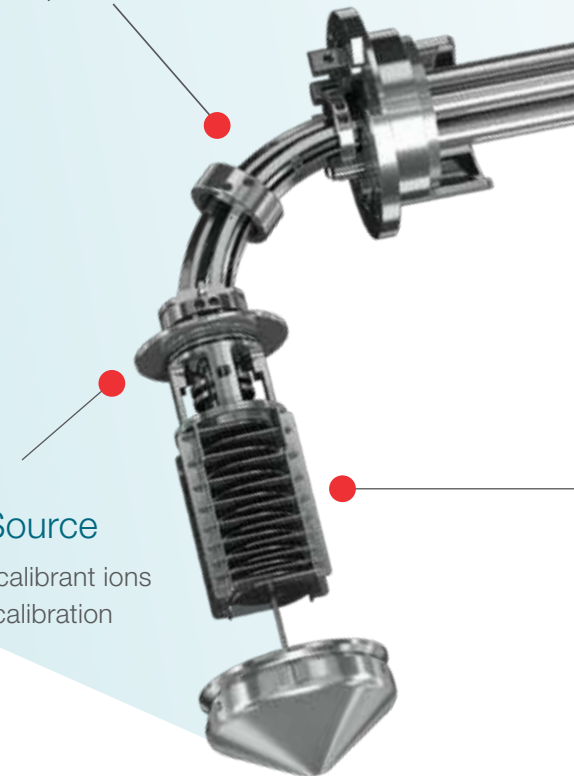

Ultra-High-Field Orbitrap Mass Analyzer

Offers resolution up to 500,000 FWHM and MSⁿ scan rates up to 30 Hz

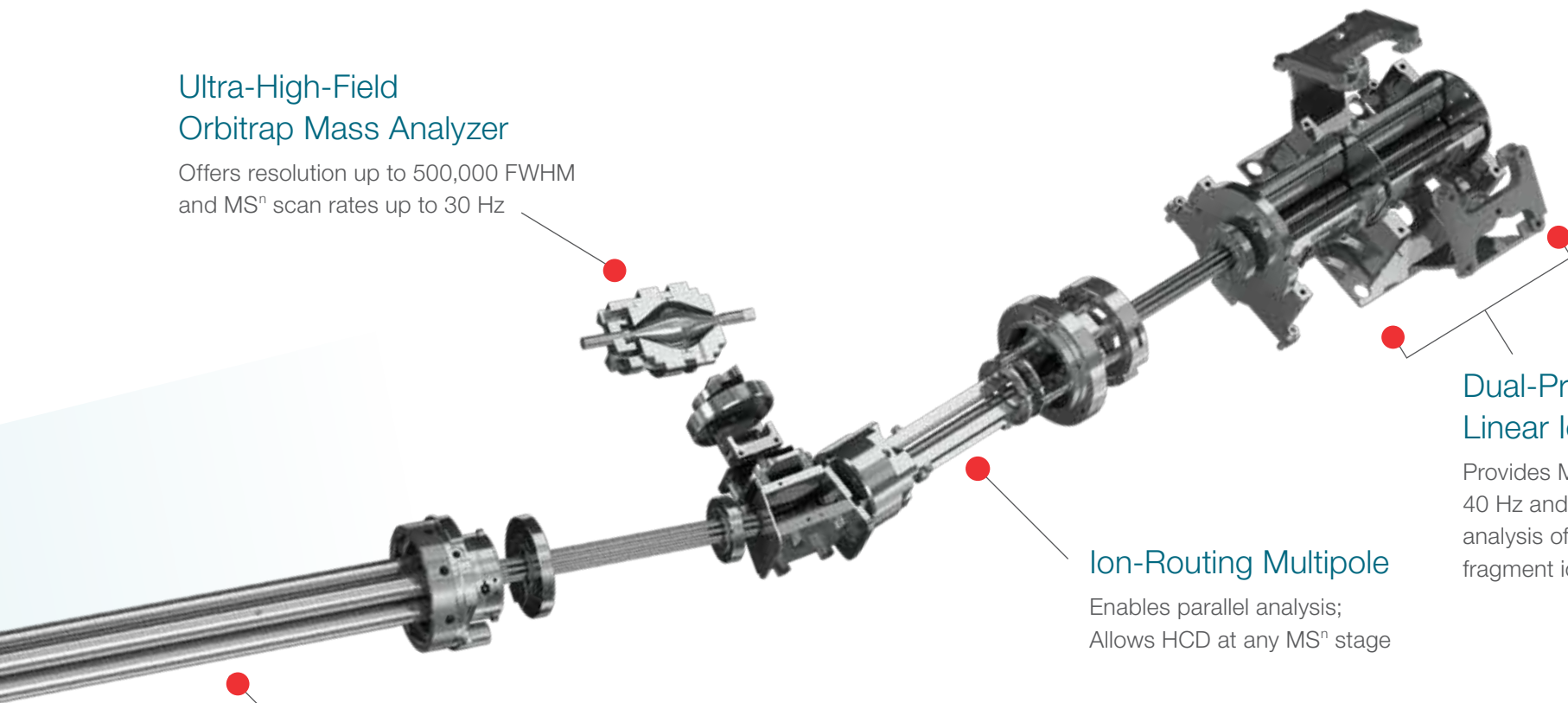

Dual-Pressure Linear Ion Trap

Provides MSⁿ rates up to 40 Hz and sensitive mass analysis of CID and HCD fragment ions

Ion-Routing Multipole

Enables parallel analysis;
Allows HCD at any MSⁿ stage

Quadrupole Mass Filter

Selects precursor ion with resolution up to 0.4 amu;
Yields high ion transmission from 50 to 2000 *m/z*

S-Lens

Optimizes ion transmission into the mass spectrometer, while minimizing in-source fragmentation



Focus on your science, not on instrument setup

The intuitive method editor features a user-friendly interface with predesigned optimized method templates for a wide range of applications.

The screenshot displays the 'Method Editor' software interface. At the top, there are tabs for 'Global Parameters', 'Scan Parameters', and 'Summary'. Below this is a 'Method Timeline' section with a 'Method Duration (min)' slider set to 120. The main workspace is divided into three sections: a left sidebar with 'System Templates' (including 'Fatty Acids & Lipids', 'Impurity', 'Library builder', 'Lipidomics', 'Metabolites', 'Metabolomics', 'Custom Templates', and 'My Experiments') and a central area showing a list of templates such as 'AcquireX Exclusion-Inclusion reference', 'AcquireX Identification - MS2 HCD-CID', 'AcquireX Identification - MS2', 'AcquireX Identification - MS3', 'Identification - MS2', 'Identification - MS3', 'MS1 profiling', 'Structure specific MS4 (monosaccharide loss)', 'Structure specific neutral loss dependent MS3', and 'Structure specific product ion dependent MS3'. A red dot highlights the 'Metabolomics' category in the sidebar, and another red dot highlights the 'AcquireX Identification - MS3' template. To the right, a 'Properties' panel is visible. The central area also contains a detailed flowchart of a method configuration, starting with 'MS OT' (Intensity, Dynamic Exclusion, Targeted Mass Exclusion) leading to 'Targeted Mass', which then branches into 'dMS² OF HCD' (Precursor Selection Range, Intensity, Precursor Ion Exclusion, dMS² IT CID) and 'dMS² OF HCD' (Precursor Selection Range, Intensity, Precursor Ion Exclusion, dMS² IT CID). The flowchart includes numbered steps (1, 2, 3) and icons for 'DA scan' and 'MS scan'.

Effortlessly run advanced experiments for a variety of applications using validated method templates

Ready-to-use templates with predefined instrument parameters enable generation of high-quality data regardless of analyte chemical structure.

Match experimental design to your challenging samples

Three modes of AcquireX intelligent data acquisition enable rapid profiling of multiple samples or exhaustive interrogation of replicate sample injections. Each mode increases the number of compounds sampled with distinguishable fragmentation spectra to use for sample and study characterization.

● Background Exclusion

Increase the MSⁿ sampling efficiency of unknown compounds within one replicate individual, or batch analysis.

● Exclusion and Component Inclusion

Increase the breadth and depth of compound identification and structural elucidation using various ion tree experiments.

● Deep Scan with inclusion and exclusion

Attain exhaustive characterization using fully-automated, complex data acquisition enabling comprehensive sample interrogation.

MS internal calibration adds confidence

The Orbitrap ID-X Tribrid mass spectrometer instrument calibration routine ensures high mass measurement accuracy over the mass range used for small molecule analysis, regardless of the MSⁿ level. The result is high confidence in structural analysis and elucidation for low *m/z* ions within a sample and over extended periods of time.

Excellent scan-to-scan mass measurement accuracy

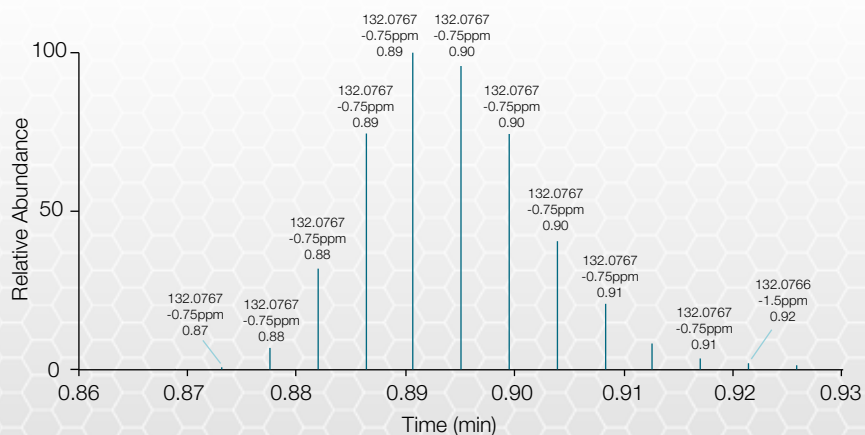

Orbitrap ID-X Tribrid mass spectrometer analysis of creatine (theoretical *m/z* of 132.0768) LC-MS analysis.

Unprecedented run-to-run mass measurement accuracy

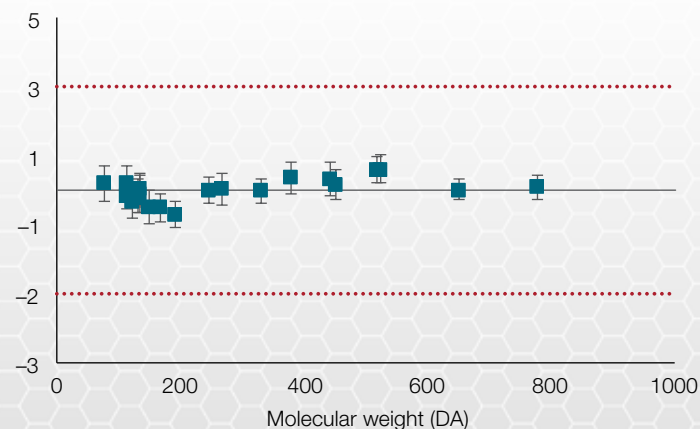

Cumulative mass measurement accuracy for replicate LC-MS analyses of 24 small molecule standards conducted over 72 hours.

Collect more meaningful data, not just more data

Intelligent AcquireX efficiently acquires data with significantly less manual experimental setup and interpretation expertise required.

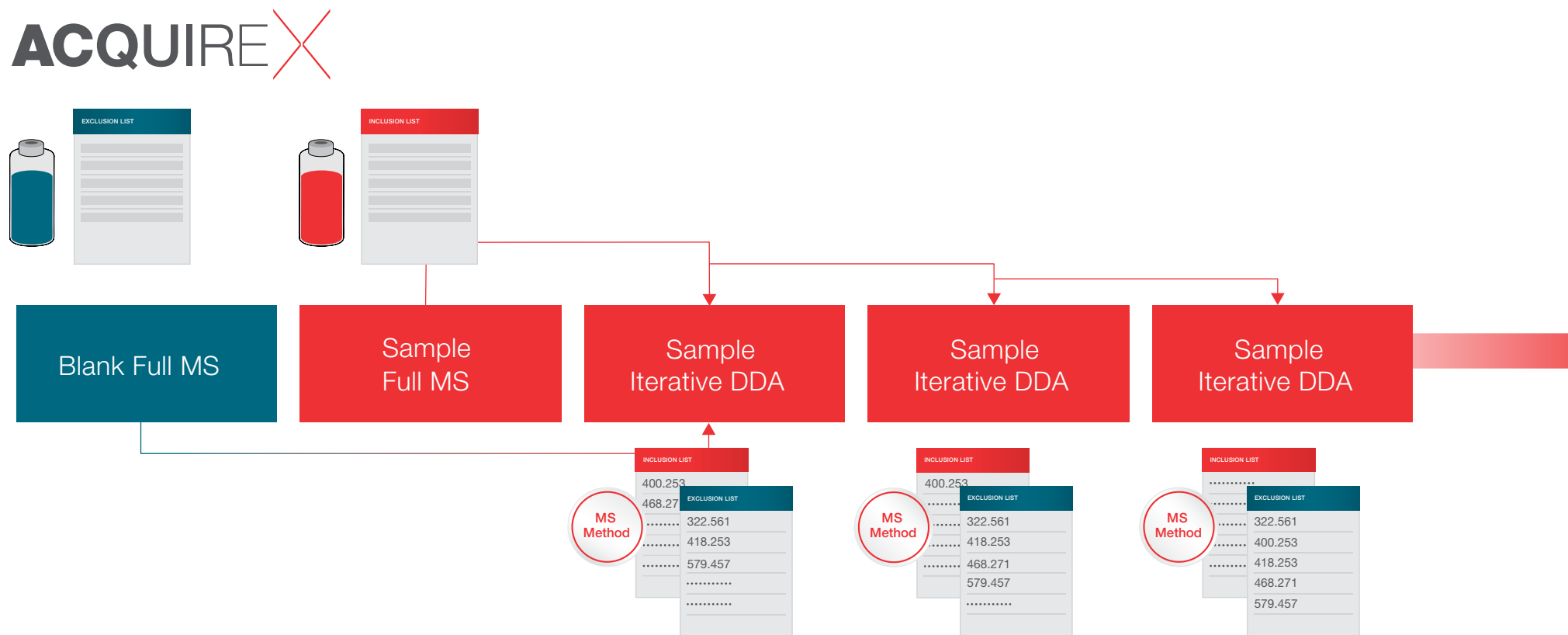

The three modes of AcquireX data acquisition permit rapid profiling across multiple samples or exhaustive sample interrogation through replicate injections. Initial analysis of a blank and representative sample enables automated creation of an inclusion/exclusion list used to direct DDA sample analysis. Each replicate injection increases the number of compounds sampled with distinguishable fragmentation spectra for sample and study characterization.



Fragment more unique unknown compounds

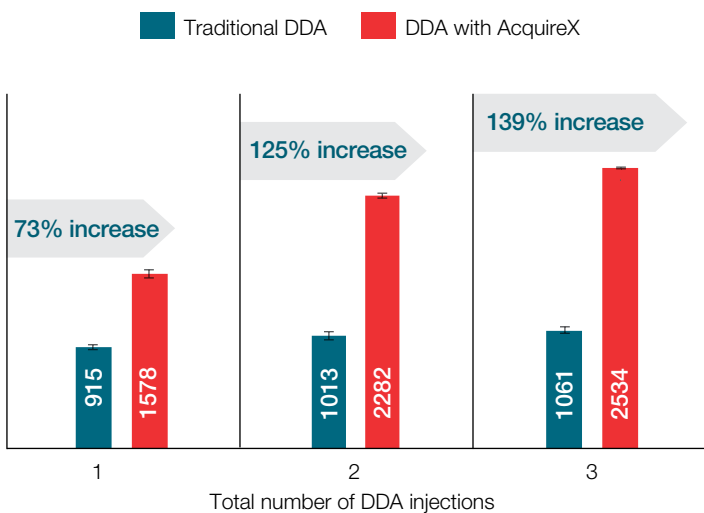

Detect up to 140% more unique unknown compounds that are truly experimentally related, even at low abundance as shown in this example of three replicate injections of the NIST SRM 1950 plasma extract sample.

Obtain more distinguishable fragmentation

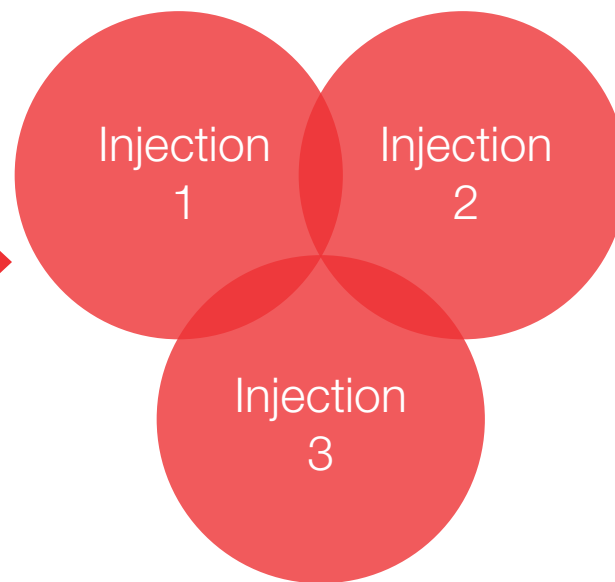

The AcquireX Intelligent data acquisition approach samples more compounds with distinguishable product ion spectra. With each iteration and subsequent injection, the same compounds chosen to be fragmented are eliminated, minimizing redundancy.

Go beyond traditional untargeted metabolomics

Increase metabolome coverage and confidence in unknown identification.

Insufficient metabolome annotation has limited the biological interpretation of untargeted metabolomics studies. The Orbitrap ID-X mass spectrometer provides a streamlined approach to routinely achieve comprehensive metabolome coverage with confident compound annotation against spectral libraries to provide compound annotations or perform *de novo* structural elucidation of unknown metabolites. The power of HRAM Orbitrap mass analyzer technology with AcquireX intelligent acquisition of MSⁿ spectra reinvents the way metabolomics is done today.

HIGHER EFFICIENCY

Number of compounds with fragmentation spectra

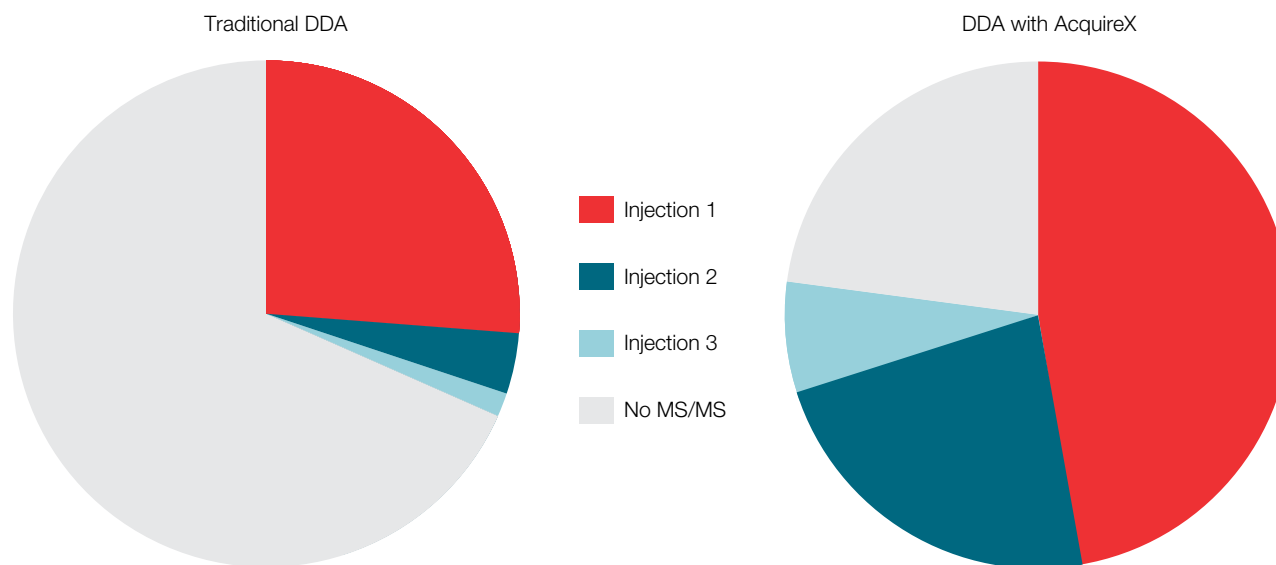

The Orbitrap ID-X Tribrid mass spectrometer improves precursor sampling by automatically updating the inclusion/exclusion lists following each replicate. The data-informed AcquireX approach utilizes sequential injections to interrogate more unique sample components through MSⁿ acquisition. AcquireX more than doubled the number of unique compounds with fragmentation spectra in human plasma (NIST SRM1950) in comparison to traditional DDA, resulting in a greater metabolome coverage.

“Confident metabolite identification remains a challenging step in the untargeted metabolomics workflow where the data acquired are applied to derive the structure of all metabolites detected. Progress has been made to putatively annotate metabolites using MS or MS/MS data using established UHPLC/MS assays through the use of metabolomics database and mass spectral library searching workflows. The Orbitrap ID-X Tribrid MS delivers complementary information with multiple dissociation techniques and robust MSⁿ data required to deduce structural information and increase confidence in metabolite annotation. With built-in intelligent data acquisition, AcquireX, we now collect more informative data, and not just more data, we can maximize metabolome coverage and increase confidence in the identification on unknowns applying intelligent-DDA approaches.”

—Warwick Dunn, PhD, Professor in Analytical and Clinical Metabolomics, Phenome Centre Birmingham, School of Biosciences and Institute of Metabolism and Systems Research, University of Birmingham, UK

HIGHER QUALITY

Complimentary MSⁿ fragmentation of kynurenine metabolite

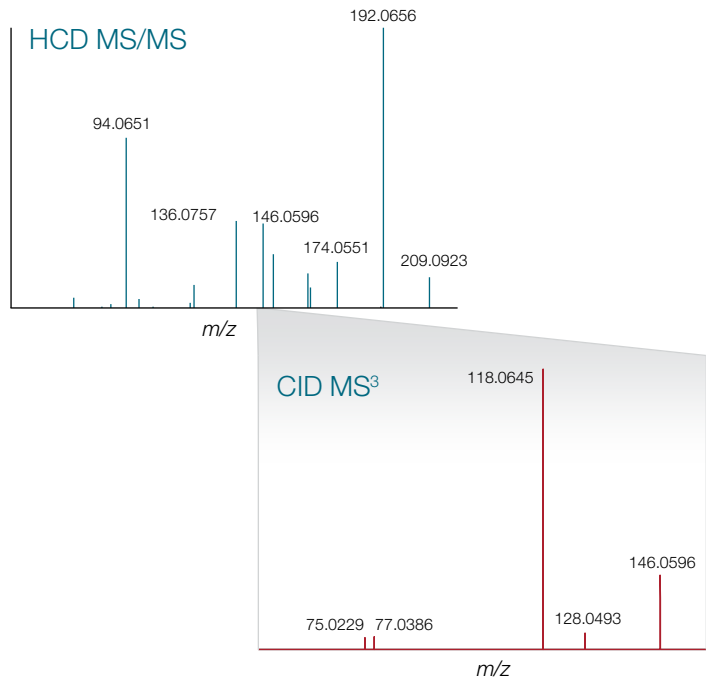

The Orbitrap ID-X Tribrid mass spectrometer offers MSⁿ fragmentation and the flexibility of complementary HCD and CID techniques to increase the probability of generating information-rich product-ion spectra across more compound classes. In this example, fragmentation of the metabolite kynurenine illustrates the complementarity of HCD and CID.

Metabolite intermediate kynurenine identified in a Crohn's disease study

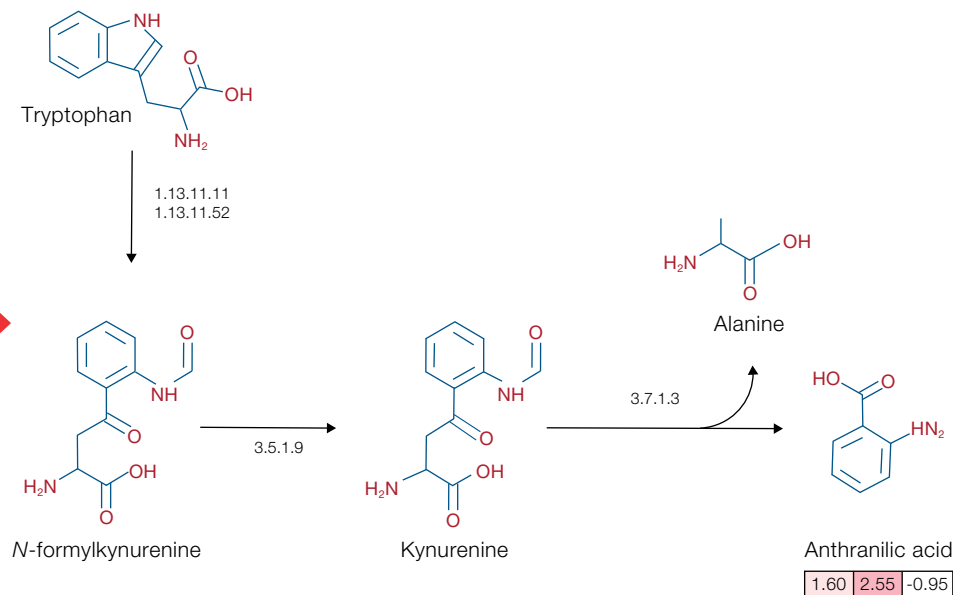

Annotation of more high-quality spectra leads to improved metabolome coverage, comprehensive pathway annotation, and functional interpretation of results. Confident annotations of metabolites in the tryptophan degradation pathway enabled detection of changes in the levels of anthranilic acid in a comparison among healthy donors and donors with Crohn's disease.

Abundantly certain in no time

Identify and characterize structures of small molecule pharmaceuticals.

In pharmaceutical research and development, small molecule characterization plays a critical role in active pharmaceutical ingredient (API) impurity and metabolite identification, degradation profiling, and analysis of extractables and leachables. High-resolution mass spectrometry (HRMS) is a pivotal tool for these applications. The Orbitrap ID-X Tribid mass spectrometer elevates HRMS to a new level. With AcquireX intelligent data acquisition, complex matrix interferences are removed by automatic background exclusion, ensuring the capture of low-abundance analytes and significantly improving identification. Information-rich MSⁿ fragments provide in-depth structural knowledge of compounds, and facilitate high-confidence identification of unknown or unexpected compounds.

Coupled with the powerful spectral library and data processing software, the Orbitrap ID-X Tribid mass spectrometer provides the ultimate solution for small molecule structural analysis, significantly increasing accuracy, efficiency, and overall productivity in drug impurity and metabolite identification, extractable and leachable analysis, and other related applications.

Impurity analysis performed using AcquireX data acquisition

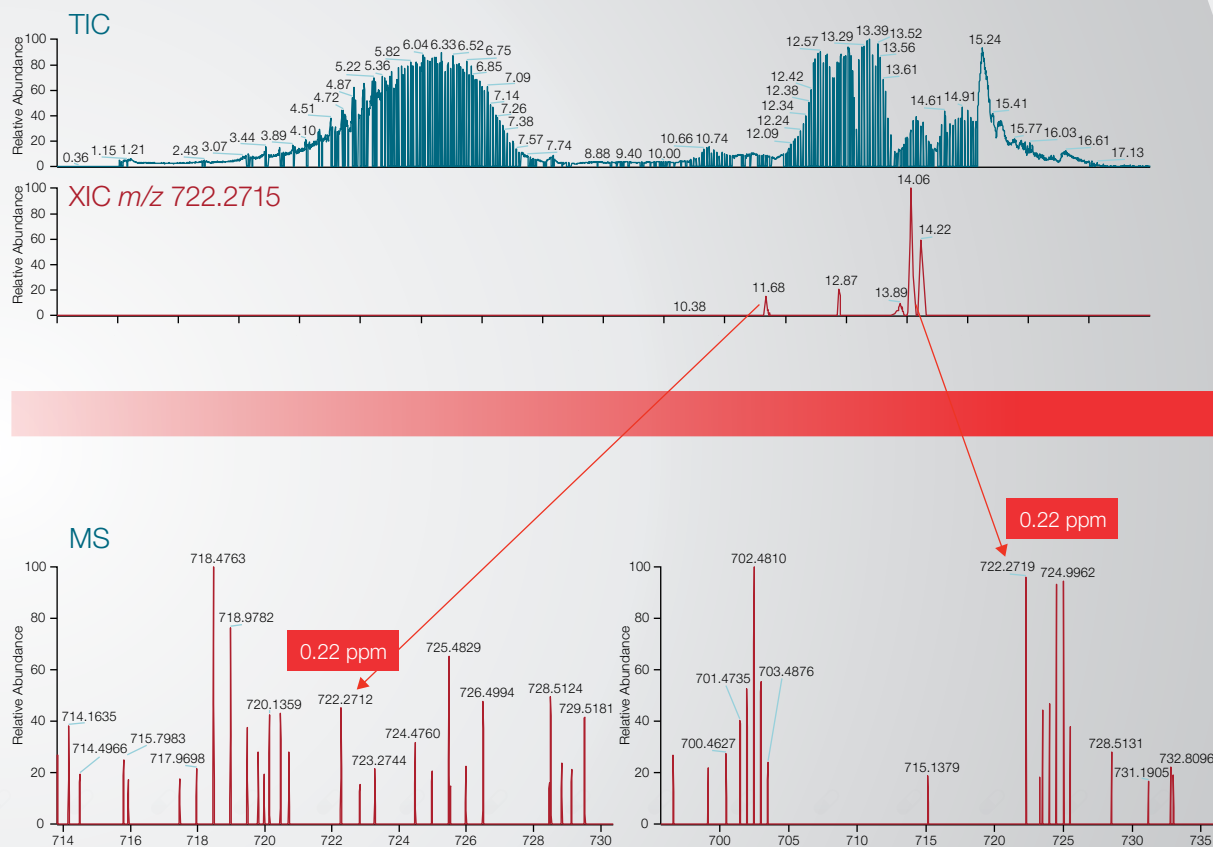

Analysis of the excipient sample, along with an analysis to determine background precursors was performed. Background precursors were automatically incorporated into an exclusion list and imported into the refined method. The exclusion list significantly decreased the number of compounds of interest targeted during the DDA method, resulting in more efficient MS/MS and MS³ data acquisition. The highlighted retention times show the measured elution times for two isomeric impurities.

MS³ spectral analysis enables differentiation of impurity structures

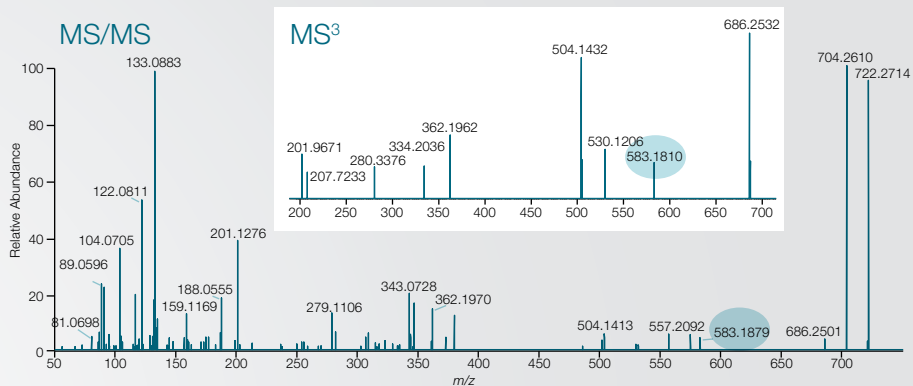

Overlaying ion tree spectra with *in silico* dissociation mechanisms to propose impurity structures

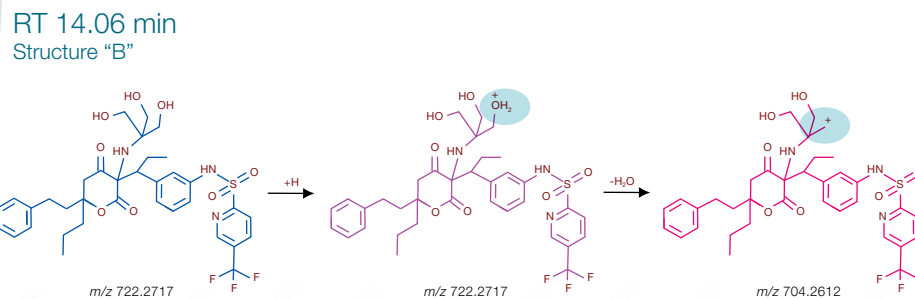
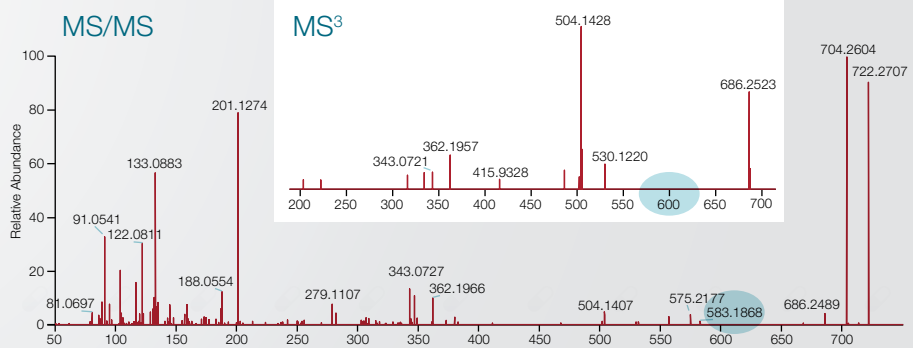
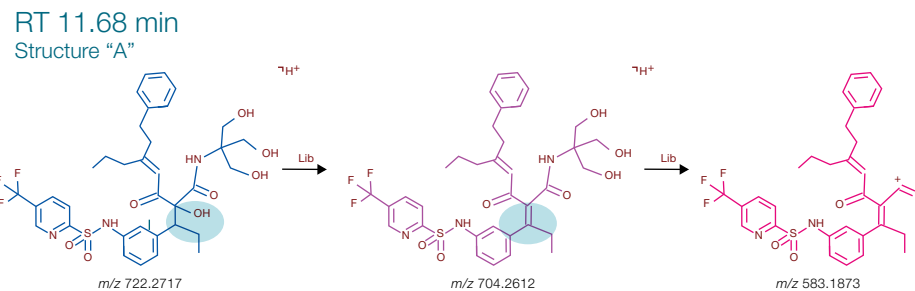

HRAM MS/MS and MS³ spectra acquired at the retention times 11.68 and 14.06 minutes. The comparative MS/MS spectra show complex, but conserved fragmentation, reducing the confidence in proposing precursor structures that lead to different elution profiles. Specifically, the MS/MS product ions at m/z 704 and 583 are detected for both m/z 722 precursors, however when the m/z 704 MS/MS product ion is isolated and fragmented, only the structure eluting at 11.1 minutes has an MS³ product ion at m/z 583, indicating different precursor structures.

Plausible precursor and product ion structures were evaluated using the Fragments and Mechanisms tool in Thermo Scientific™ Mass Frontier™ 8.0 software. The fragmentation pathways of two plausible structures were evaluated for fragmentation pathways to predict formation of the m/z 583.1873 product ion. Structure A has a direct fragmentation pathway justifying the fragmentation of m/z 704 to form the m/z 583 product ion. Structure B predicts that m/z 583.1873 fragment would originate from the m/z 601 MS/MS product ion instead of the m/z 704 product ion.

Demystifying unknowns using high-quality MSⁿ data annotation

Take advantage of superior MSⁿ data coupled with selective mass-spectral prediction tools and conquer unknown identification challenges.

High-quality MSⁿ data generated by the Orbitrap ID-X Tribrid mass spectrometer combines precursor ion fingerprinting with substructure analysis to facilitate unknown identification. MSⁿ provides more relevant ion fragment information, helps identify isomeric species, and aides unknown compound structure annotation. By performing an MSⁿ tree/subtree search in Mass Frontier 8.0 software against the mzCloud mass spectral library, the substructures present in an unknown compound can be identified by matching the partial MSⁿ spectral tree data. The partial matches can be rank ordered using mzLogic and/or the FISh score to propose the best candidates.

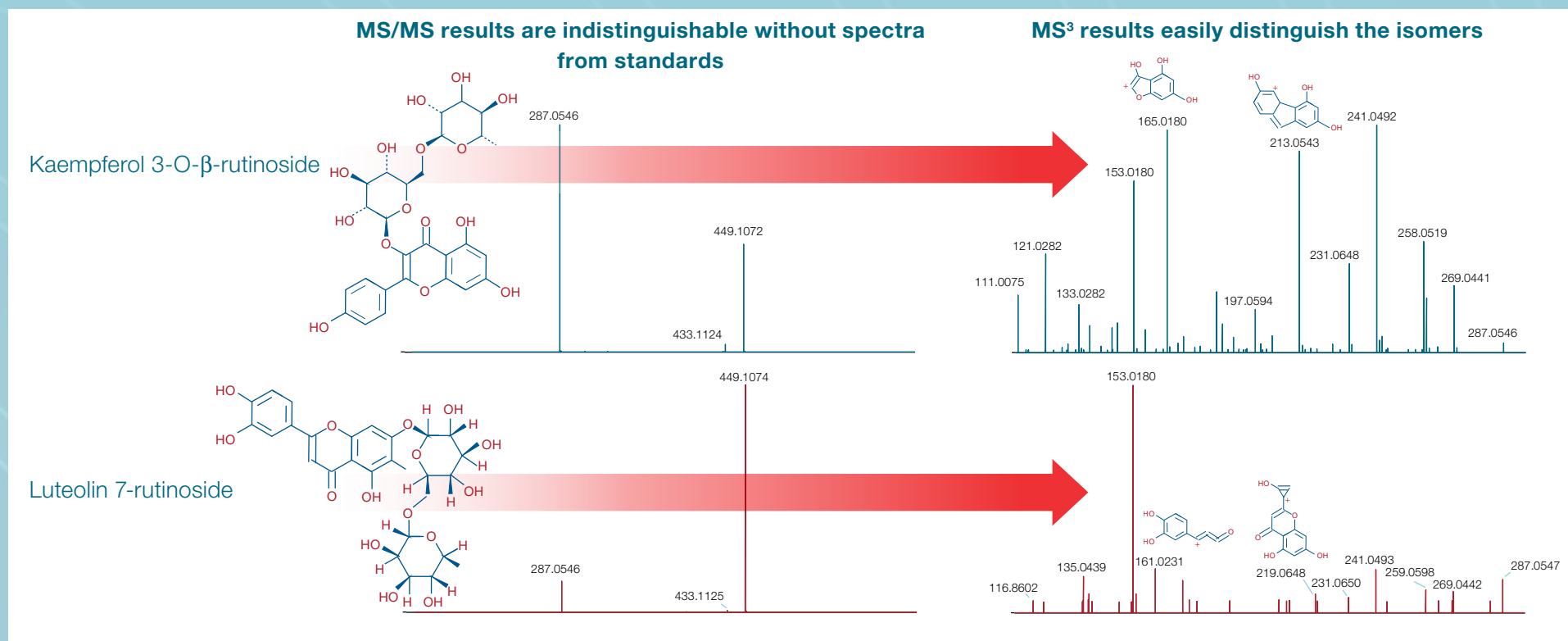

Comparative MS/MS spectra for two flavonoid structural isomers where the only structural difference is associated with an aglycone substructure. The addition of the two sugar rings to the base aglycone substructure results in similar MS/MS spectra, prohibiting correct structural identification despite low mass errors for precursor and MS/MS product ions. Incorporation of neutral-loss triggered MS³ acquisition and subsequent analysis results in clearly defining two isomeric compounds.

Meet your data analysis requirements with speed, simplicity, and flexibility

Overcome challenges in small molecule full-scan data analysis and interpretation with Compound Discoverer software.

Thermo Scientific™ Compound Discoverer™ software efficiently extracts high-confidence insights from information-rich, small-molecule HRAM data. It serves as a hub to seamlessly connect you to the tools needed to analyze large amounts of HRAM data productively and confidently.

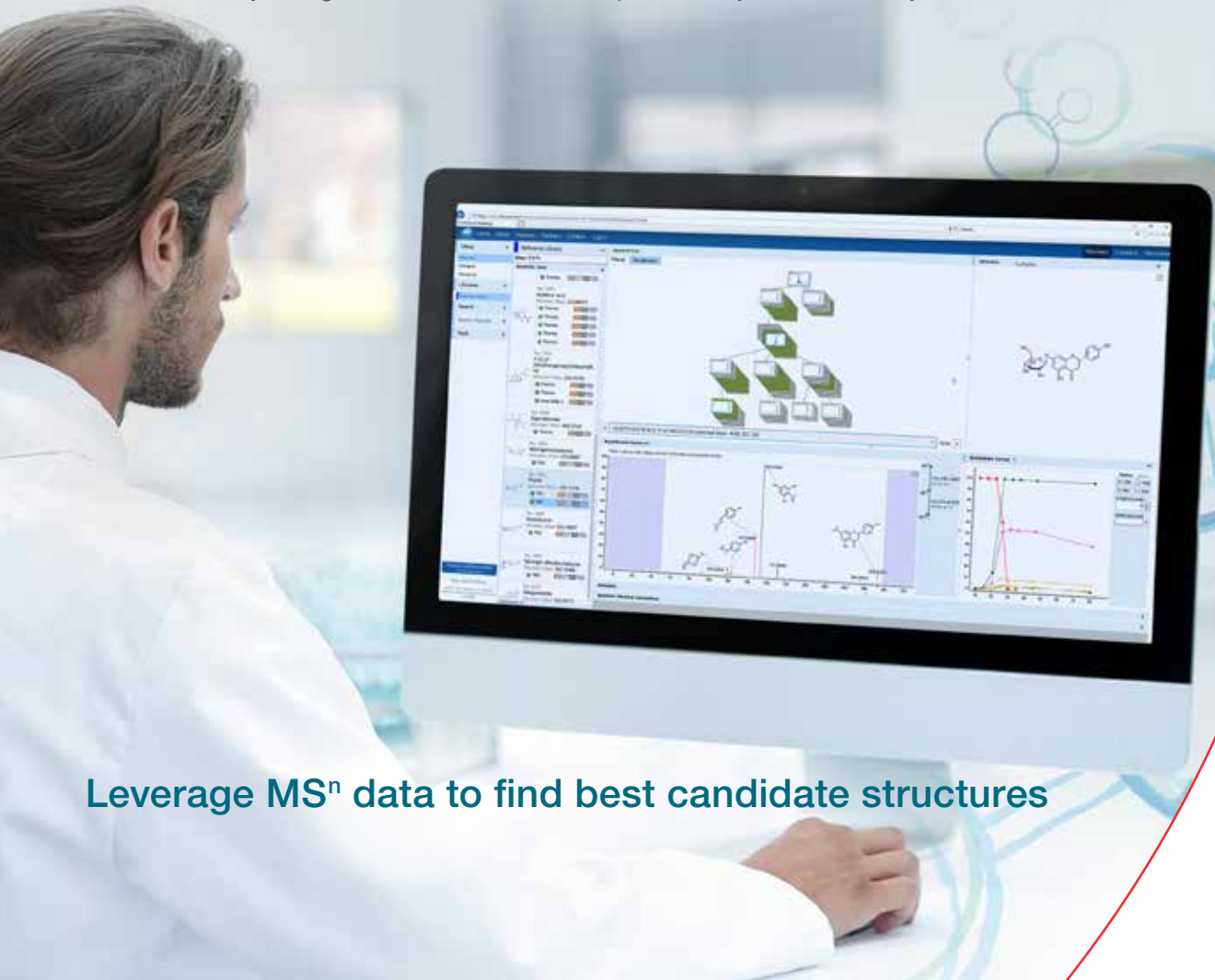

Leverage MSⁿ data to find best candidate structures



mzCloud™ mass spectral library

Rank search more effectively with the industry-leading online spectra fragmentation library

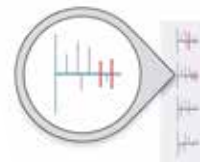

mzLogic algorithm

Fast, automated logical analysis eliminates thousands of candidates and hours of work



Mass Frontier spectral interpretation software

Supports MSⁿ spectral ion tree searching and custom libraries



Thermo Fisher Cloud

Monitor your system, access your data and system remotely and securely from anywhere in the world. Leverage real-time monitoring of your instrument with automatic email notifications anytime, anywhere. Store data in secure accounts and share with colleagues and collaborators around the world.

Technical support: peak performance for your instruments

Helping you keep your instruments running at peak performance is our goal. Whether you're looking for an instrument manual or spare parts or want to submit a repair request or check on the status of your warranty or service contract, we have every support option you're looking for.

Protecting your investments: unparalleled laboratory services

Unity™ Lab Services provides a single source for integrated lab service, support, and supply management. Our customized service offerings and world-class service experts have the flexibility and experience to effectively address your laboratory's business needs. We provide a complete portfolio of services and support solutions designed to help you improve productivity, reduce total cost of ownership, and ensure performance throughout your laboratory—from instrument and equipment acquisition to disposition.

Find out more at thermofisher.com/orbitrapID-X