



LC-MS

Beyond innovation

Redefining low-flow sample injection
with the Vanquish Neo UHPLC system autosampler



Precise sample injection is crucial for achieving accurate and reproducible results. Completely redesigned, the Thermo Scientific™ Vanquish™ Neo Split Sampler NT hosts many new and innovative features which make daily life in the lab easier and results better. The autosampler supports multiple separation workflows and applications covering the low nano- to micro-flow rate range. Its high injection precision and reproducibility across a broad injection volume range spanning four orders of magnitude ensure comprehensive analysis for all sample types and concentrations. So, you can have confidence in your results every time.

Redefining low-flow sample injection with split-loop design for low-flow analyses

Historically, low-flow HPLC systems have adopted pulled-loop autosamplers for sample introduction. Pulled-loop autosamplers have the advantage of generating lower gradient delay volumes—the volume from the point of mobile phase mixing to the column head—than split-loop autosamplers where both the needle and sample loop are part of the flow path. However, pulled-loop autosamplers often aspirate excess sample which is ultimately wasted, and suffer from lower injection volume precision, limited range of injection volumes, and increased carry-over.

The Vanquish Neo autosampler unites the best of both principles (Figure 1). Its split-loop design was optimized to meet the demands of low-flow applications: low gradient delay volume, high injection volume precision, injection from limited sample volumes, and low carry-over.

The Vanquish Neo autosampler design possesses many benefits. For example, highly precise and reproducible injections for a wide variety of injection volumes—from 10 nL to 500 μL —are possible without the need to draw excess sample volume or use a transfer liquid. To achieve high injection precision and accuracy, sample aspiration is performed by the metering device. It can accurately aspirate sample volumes from 10 nL up to 100 μL with a single stroke. Multi-draw functionality supports larger injection volumes for trap-and-elute workflows through iterative sample pick-up. After each aspiration, the respective sample volume is transferred to the trap column. This is repeated until the full sample volume has been completely transferred to the trap column.

Gradient delay volume directly impacts the required LC run time. The higher the delay volume, the longer it takes the gradient to reach the separation column. At lower flow rates this effect becomes more pronounced. In order to minimize the gradient delay volume in nano- and capillary-flow set-ups (up to 5 $\mu\text{L}/\text{min}$), the sample is pushed from the loop to the column head after which the loop is switched offline for the gradient separation (Figure 2). The resulting gradient delay volume for nano- and capillary-flow applications is subsequently less than 0.5 μL . For micro-flow applications, optional loop switching enables you to match the system volume to both nano/capillary-flow or analytical flow applications.

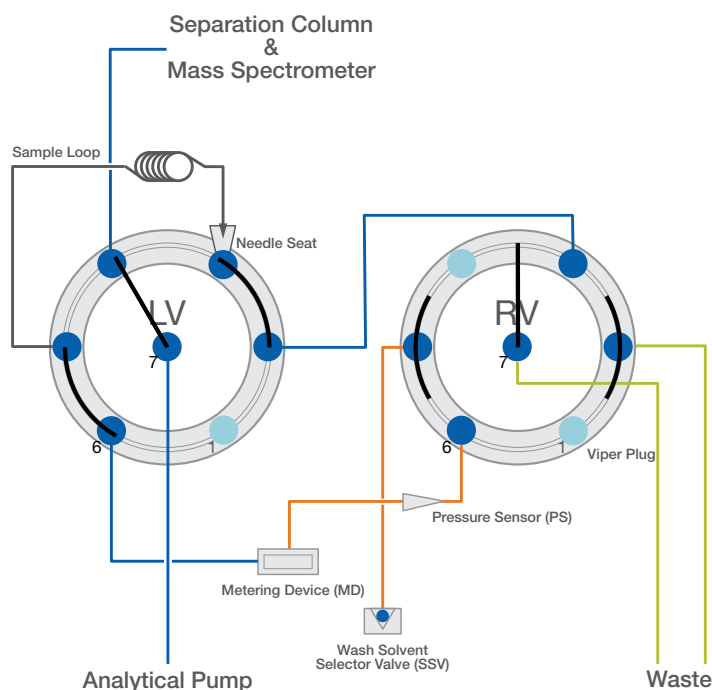

Figure 1: Flow scheme for direct injection during the gradient delivery phase. The sample loop is switched offline to reduce the gradient delay volume.

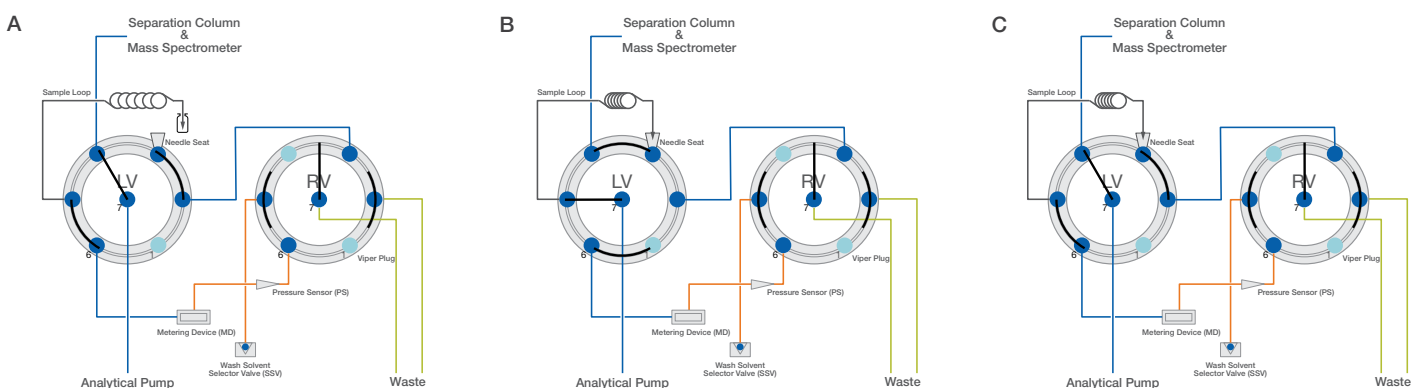

Figure 2: (A) Sample pick-up, (B) loading onto the separation column and (C) gradient delivery phase with the sample loop offline from the analytical flow path.

Adapting the system to your science—one system, multiple workflows

There is no single approach ideally suited to the introduction and separation of all sample types in low-flow LC-MS. For this reason, the Thermo Scientific™ Vanquish™ Neo UHPLC system has been designed with full flexibility in mind, offering built-in multi-workflow capabilities each tailored to the respective analytical need. In the autosampler, this versatility is achieved through two specially developed valves, the metering device, and the Thermo Scientific™ Viper™ and nanoViper™ Fitting systems. These are combined with system-wide intelligent system control functionality permitting bi-directional communication between the pump, autosampler, and, if present, the column compartment. The system can be configured for direct injection workflows where only a separation column is used (Figure 1) or trap-and-elute workflows where samples are first loaded onto a short trap column before the analytical separation (Figure 3). Switching between direct and trap-and-elute workflows can be easily achieved without requiring additional modules. The metering

device aspirates the sample into the loop in direct injection mode whereas in the trap-and-elute mode it both aspirates the sample and acts as a loading pump, transferring the sample from the sample loop onto the trap column. Both workflows are available for nano-, capillary-, and micro-flow rates. In trap-and-elute workflows, the trap column can be operated in forward or backward flush mode without requiring any hardware changes (Figure 3). Instead, the desired mode is simply selected during the method set-up. In forward flush mode the analytes are eluted in the same direction as they are loaded onto the trap column. Forward flush is recommended for samples potentially containing insoluble particulates derived from sample preparation routines. In this mode, the trap column protects the separation column, behaving similarly to a guard column. In backward flush, the analytes are eluted from the trap column by reversing the flow direction. While this results in sharper chromatographic peaks, a sample free of particulates is essential to avoid blockage of the separation column.

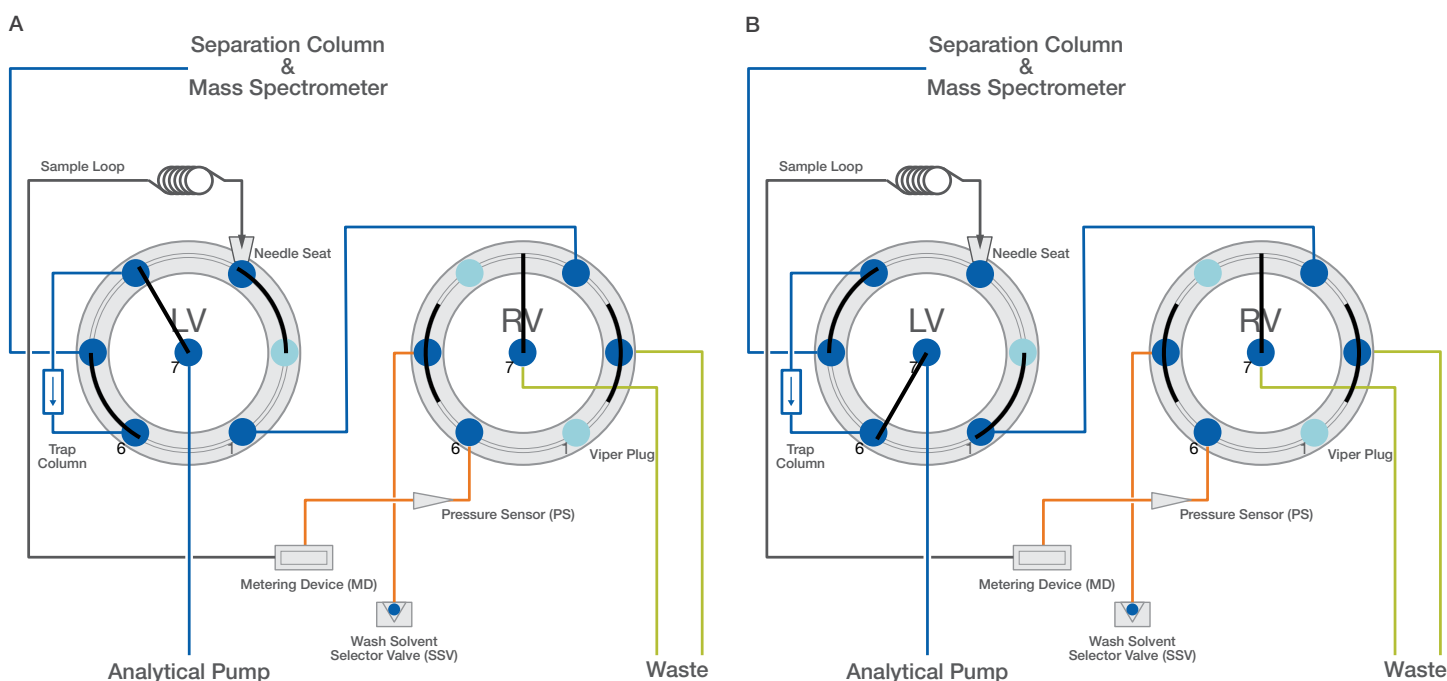

Figure 3: Trap-and-elute workflow set-up. The valve positions during the gradient delivery stage for (A) forward and (B) backward flush are shown. The arrows on the trap column indicate the flow direction during sample loading onto the trap column.

Avoiding cross-contamination from sample to sample—dedicated wash procedures minimize carry-over

High sensitivity is one of the main benefits of low-flow liquid chromatography, but increased sensitivity carries with it the need for uncompromising system cleanliness. System carry-over often presents challenges in low-flow applications, especially with respect to very hydrophobic analytes. The Vanquish Neo autosampler sets a new standard in minimizing carry-over with specialized wash protocols for the injection needle, needle seat, the sample loop and, for trap-and-elute workflows, the trap column. The outside of the needle is washed in a dedicated wash port after the sample is drawn from the vial using two different solvent types. First a “strong” (high organic containing solvent for reversed-phase (RP) separations) wash liquid is used, followed by a “weak” (aqueous solvent for RP separations) wash liquid. This ensures that no residual sample on the outside of the needle is transferred to the next sample and that no high organic wash liquid is introduced into the eluent stream, eliminating cross-contamination and improving peak shape, respectively.

While washing and equilibration of the needle and loop using the gradient pump are assured if both are kept online during the separation step, a significant increase in gradient delay volume results. This will either severely limit throughput and MS utilization in the case of capillary and even some micro-flow rate applications, or render the separation practically impossible as is the case for nano-flow rate applications.

For this reason, the Vanquish Neo autosampler adopts an “offline” sample loop approach for nano- and capillary-flow rates with the option for having loop offline or online for micro-flow separations. The Vanquish Neo autosampler ensures that minimal contributions of the hardware components to sample carryover even when the loop and needle are switched offline thanks to a dedicated washing procedure which was developed to comprehensively clean the inside of the needle, needle seat, and sample loop in parallel to the sample separation step (Figure 4). First, the metering device draws strong wash liquid from the wash port to remove contaminants, then weak wash liquid prepares the sample loop and needle for the next injection.

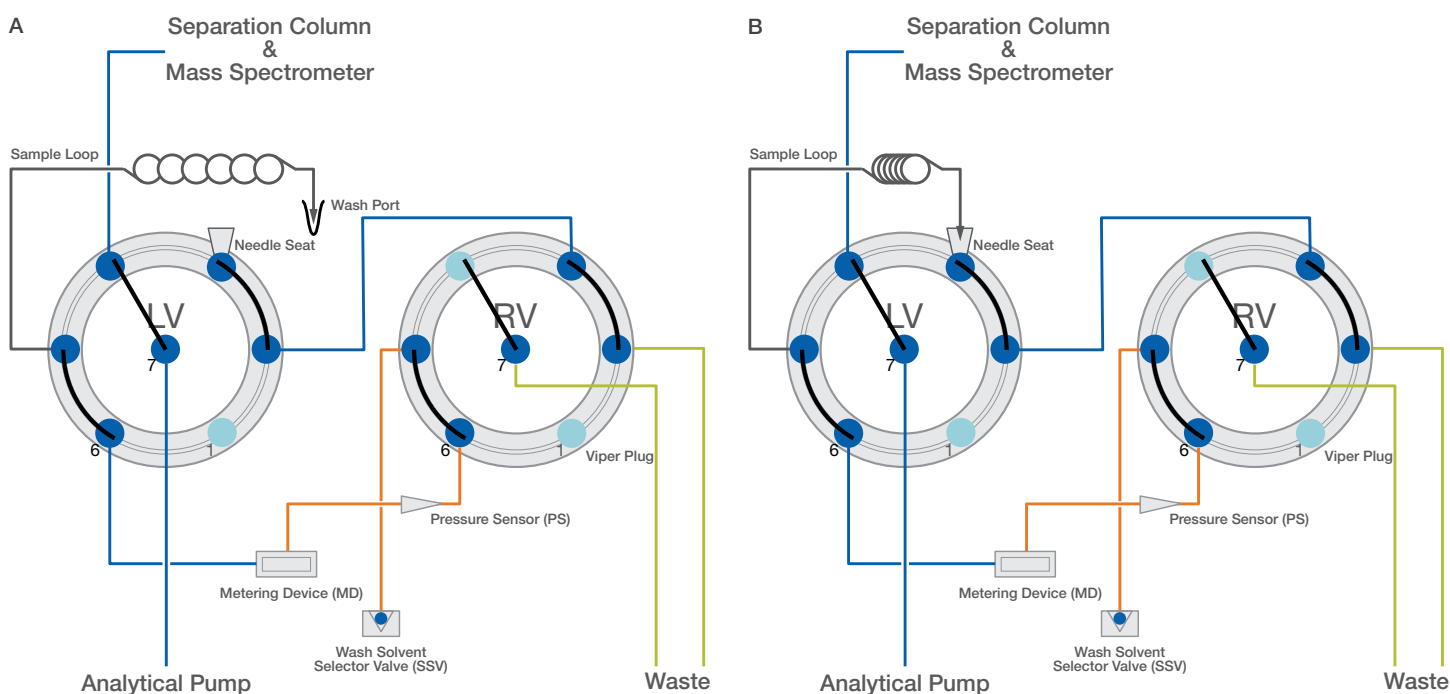

Figure 4: Needle and sample loop wash principle. First (A) strong wash liquid is aspirated from the wash port into the needle and sample loop, (B) then the needle moves back into the needle seat and the metering device pushes the strong wash into the waste. Both steps are repeated several times. Afterward, the sample loop is flushed with weak wash liquid pulled from and pushed out by the metering device (same valve positions as B).

For trap-and-elute workflows, the trap column, sample loop, and needle can be washed independently from the separation column during the wash step of the sample run. Once again using the metering device as a wash pump, the strong wash liquid is used to remove contaminants from the needle and loop followed by washing of the trap column. Weak wash liquid is subsequently used to equilibrate the trap column, the needle, and the loop and to prepare them for the next injection.

A special wash procedure was developed for samples containing strongly adhering analytes or contaminants. The ZebraWash, draws alternating strong and weak wash plugs into the needle and sample loop, before pushing them over the trap column (Figure 5). This removes even strongly bound contaminants from the trap column further reducing carry-over.

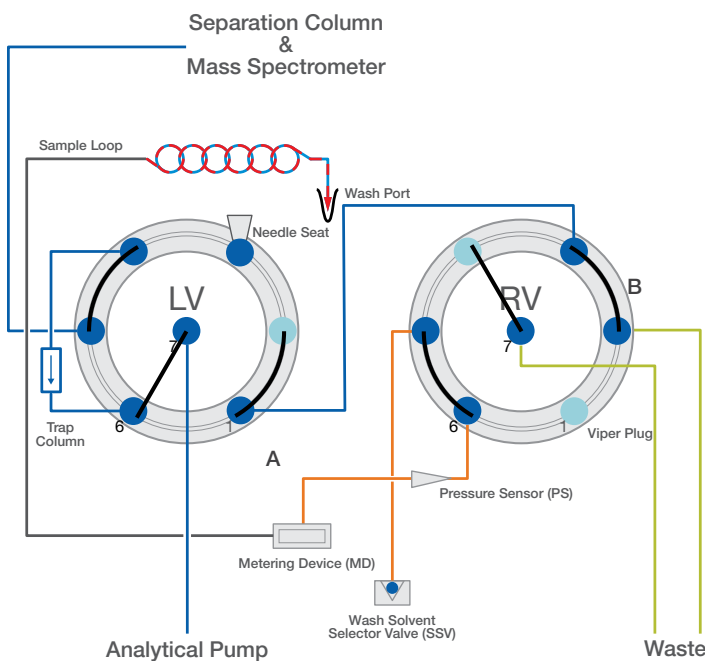

Figure 5: ZebraWash principle. (A) Strong and weak wash liquids (indicated in red and blue) are iteratively pulled from the needle wash port into the sample loop using the metering device. As a result, the loop is filled with a sequence of small plugs of either strong or weak wash liquid. Afterwards, (B) the sequence of liquid plugs is flushed over the trap column for highly efficient carry-over removal.

Improving reproducibility with SmartInject technology

Run-to-run retention time repeatability is essential for quantitative studies. Therefore, inconsistencies in the system performance must be minimized. Thermo Scientific™ SmartInject technology limits disturbance of the eluent flow when switching the autosampler loop into the flow path. As a result, retention time variation is reduced from run-to-run, particularly at the start of the gradient. SmartInject technology is also available for trap-and-elute workflows.

Other benefits afforded by SmartInject technology include reducing the effects of air bubbles inadvertently drawn into the flow path during sample aspiration into the liquid, and preventing them from negatively impacting retention time precision, and increasing column lifetime.

Making the most of your sample—obtain total sample recovery with vial bottom detection technology

Samples typically analyzed using low-flow LC applications are, by nature, often limited. The vial bottom detection technology incorporated into the Vanquish Neo autosampler enables the system to draw right from the bottom of the sample container (Figure 6). As a result, almost the complete sample volume can be injected. At the same time, it ensures that the intended sample volume is picked up even if only small volumes are present in the vial. Precise volume pick-ups are possible with less than 0.5 μL of excess sample remaining in the vial. This results in superior reproducibility for injections from limited sample volumes (Figure 7).

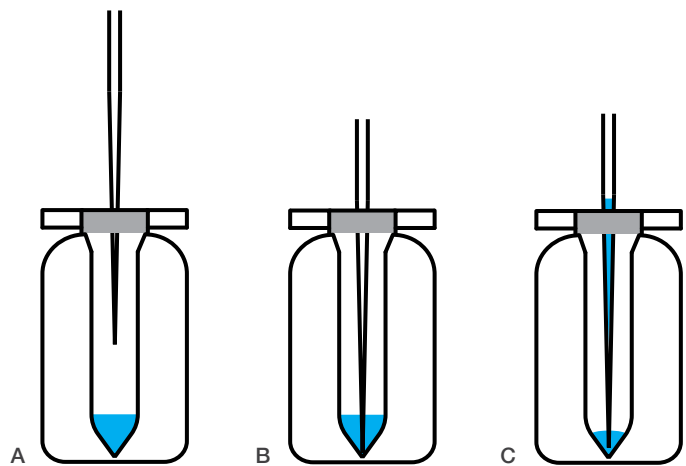

Figure 6: Vial Bottom detection procedure. First, (A) the needle punctures through the septum and moves to a start position. Then (B) it moves downwards until it gently touches the bottom of the vial. Afterwards, (C) the needle moves a few micrometers upwards and the sample is aspirated.

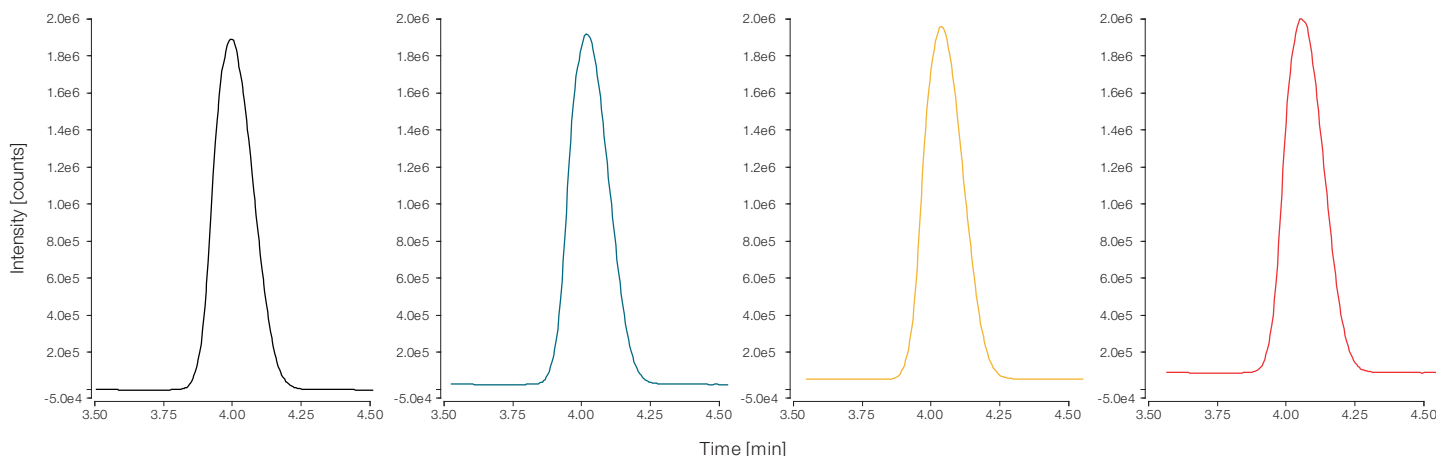

Figure 7. Injection reproducibility for small volume samples. Cortisol (10 µg/µL) was analyzed in direct injection micro-flow mode (50 µL/min flow rate) using a Thermo Scientific™ TSQ Altis™ Triple Quadrupole Mass Spectrometer. On the left, 3 µL injection from large sample volume. Other chromatograms, 3 µL injections from 4 µL sample volumes. All four injections show near-identical signal intensity indicating that vial bottom detection results in accurate sample aspiration from small sample volumes.

Redefining the standard for low-flow chromatography— great performance, every time

Gaining new insight through research requires hard work and the right tools. The Vanquish Neo UHPLC system supports you in going beyond the current limits of knowledge. It is designed to make laboratory work easier so that you can focus on interpreting the results. The system offers multiple workflows to address all of your low-flow LC-MS challenges as they arise. A broad range of innovative features including dedicated wash procedures, SmartInject technology, and vial bottom detection technology combined with an industry-leading pressure rating ensures excellent and consistent performance for every injection. The Vanquish Neo UHPLC system takes care of the separation, so you can take care of the science.

Learn more at thermofisher.com/vanquishneo

For Research Use Only. Not for use in diagnostic procedures. © 2023-2023 Thermo Fisher Scientific Inc. All rights reserved. All trademarks are the property of Thermo Fisher Scientific and its subsidiaries. This information is presented as an example of the capabilities of Thermo Fisher Scientific Inc. products. It is not intended to encourage use of these products in any manners that might infringe the intellectual property rights of others. Specifications, terms and pricing are subject to change. Not all products are available in all countries. Please consult your local sales representative for details. **SP74151-EN 1023M**