

Brochure

ThermoFisher
SCIENTIFIC

Semiconductor Solutions

thermo scientific

About Thermo Fisher Scientific

With approximately 125,000 employees, Thermo Fisher is unmatched in its global commercial reach. Our continued innovation is the key to our technology leadership. We are advancing materials characterization and in situ studies. Our technology depth is reflected in our deep applications expertise and our analytical technologies that provide new workflows and innovations.

For semiconductor manufacturers and the electronics industry, we combine our electrical analysis solutions with SEMs, TEMs, S/TEMs, DualBeam FIB/SEMs and advanced software suites to deliver root cause analysis with the highest success rate and productivity. Our industry-leading workflows deliver fast, accurate answers for accelerating IC design and production decisions. Our fault isolation and analysis products provide superior images, rich feature sets, cross-sectional metrology and automation to speed process defect identification, reduce yield loss and accelerate time-to-market for new products. Our expertise, market leadership and continued R&D commitment are paving the way to innovations in 3D gates and memory, transistor design and advanced material integration.

Thermo Fisher Scientific supplies innovative solutions for electron microscopy and microanalysis to take customers from questions to usable data by combining high-resolution imaging with physical, elemental, chemical and electrical analysis across scales and modes—through the broadest sample types.

Table of Contents

Localization	5
<i>Electrical Analysis</i>	6
Preparation.....	8
<i>Physical Analysis (SEM, S/TEM, FIB Sample Prep).....</i>	9
<i>Physical Analysis (Large Area FIB Processing)</i>	11
<i>Wafer Yield Control and Metrology.....</i>	13
Analysis	14
<i>Physical Analysis (S/TEM).....</i>	15
<i>Physical Analysis (SEM)</i>	17
<i>Surface Analysis (XPS).....</i>	19
<i>Chemical Analysis (RAMAN and FTIR).....</i>	21
<i>Chemical Analysis (IC, ICP-MS, GC-MS).....</i>	22
<i>Wafer Yield Control and Metrology.....</i>	23
<i>ESD Compliance Testing</i>	25
<i>Temperature Control (Recirculating Chillers / Heat Exchangers)</i>	27
<i>Circuit Edit.....</i>	28
CAD Navigation.....	29
<i>CAD-to-Stage Navigation Capabilities.....</i>	30
<i>Semiconductor</i>	31
Service Solutions	31
<i>Productivity and System Performance.....</i>	32
<i>Transforming service with a data-driven approach.....</i>	33
Automated Workflows	34
<i>SEM and TEM Metrology.....</i>	35
<i>Root-cause Analysis</i>	36
<i>Example: FA on Power MOSFET Devices</i>	37
<i>Product Table.....</i>	38
Further Reading	39

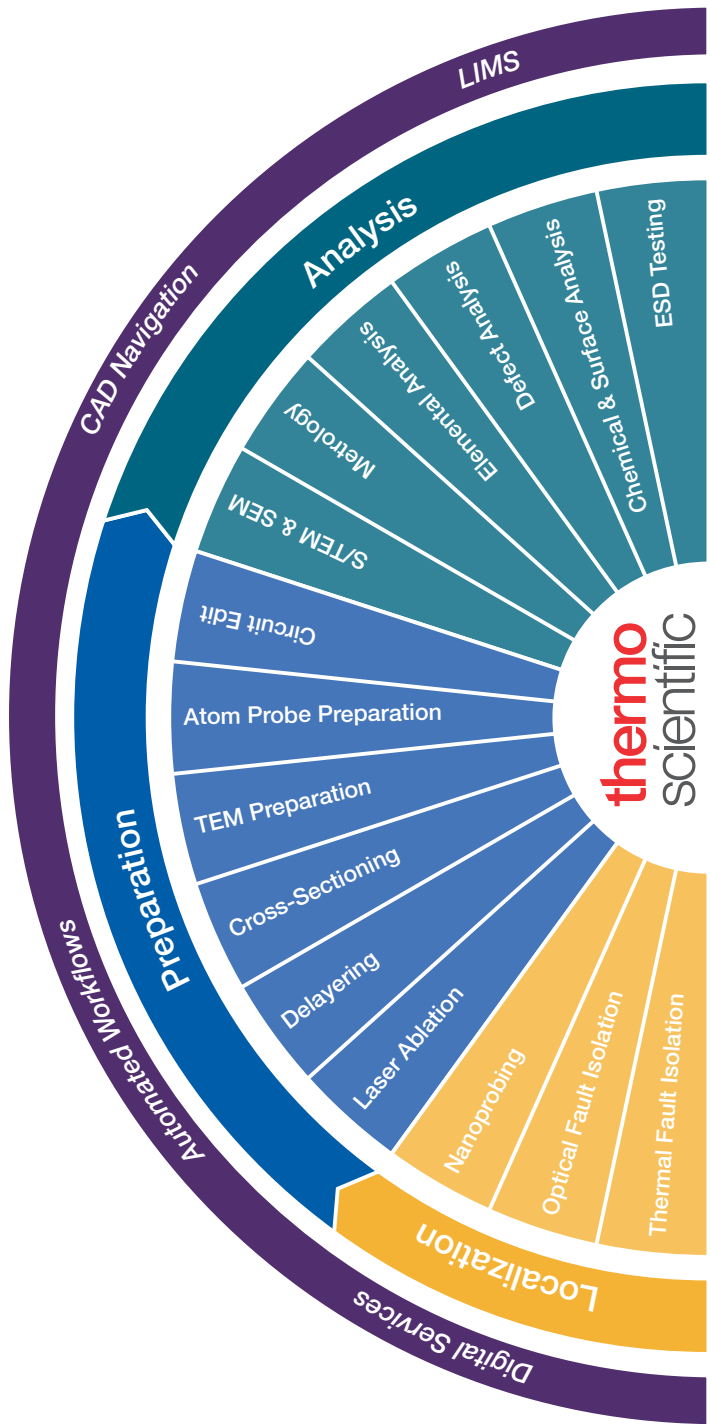

Accelerating research and development • Solving complex analytical challenges • Increasing lab productivity and yield

Localization

Shrinking technology, new materials, and increasingly complex structures are driving defectivity, especially when the circuit design is sensitive to process variation. These non-visual defects reveal themselves as electrical faults that downgrade device performance, threaten reliability, and destroy yield. Additionally, high-density interconnects, wafer-level stacking, flexible electronics, and integral substrates mean that failure-inducing defects have more places to hide, making characterization more difficult, and more critical, than ever. Our electrical analysis tools clearly identify these subtle electrical issues, significantly augmenting QC and QA oversight.

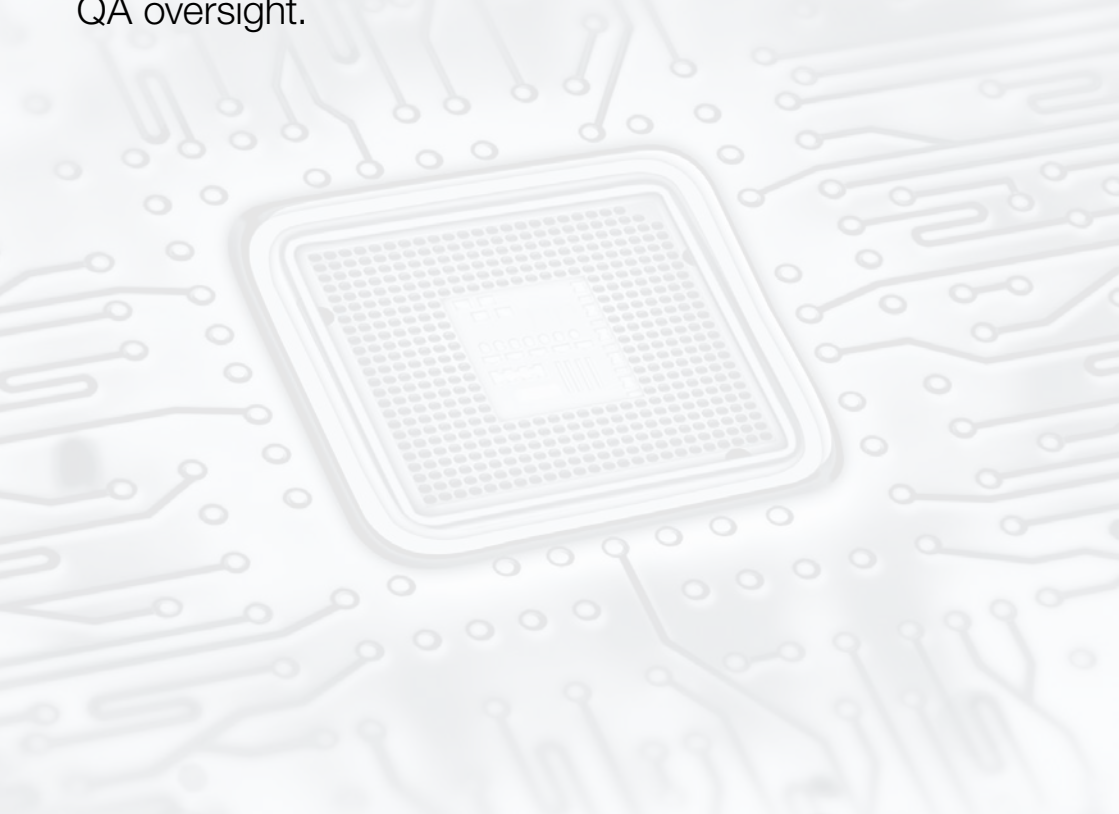

Localization

Electrical Analysis

Thermo Scientific™ ELITE™ System



Heat-based, non-destructive electrical fault localization at the die, package or wafer level

- Fast detection
- Precise localization
- 3D packaging solutions
- Thermal diagnostics
- Optional OBIRCH and laser marking capabilities

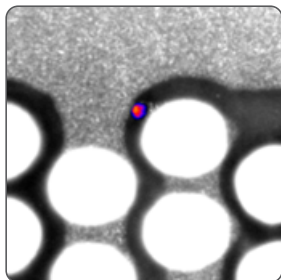

Thermo Scientific™ Meridian™ System



Electrical fault localization and circuit timing analysis at the die or wafer level, based on emission or laser stimulation

- Dynamic analysis and laser voltage imaging/probing
- Sub-cell localization
- Higher signal noise ratio (SNR)
- Configurable to support power, memory or logic applications

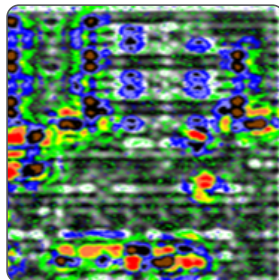

Thermo Scientific™ Meridian™ S System



Static optical fault isolation for identifying systematic process, design or integration issues and root causing electrical failures

- Fault Diagnostic with Active Probe Technology
- Static laser stimulation (SLS/OBIRCH) and photon emission options
- Supports micro-probing and probe card device stimulation

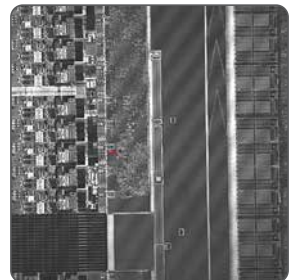

Localization

Electrical Analysis

Thermo Scientific™ nProber™ IV and flexProber™ Systems



SEM-based platform for the localization of transistor and metallization faults

- Low kV SEM
- FEOL-to-BEOL electrical failure location and characterization
- Comprehensive parametric electrical data collection
- Automated, easy-to-use, low kV for sensitive devices

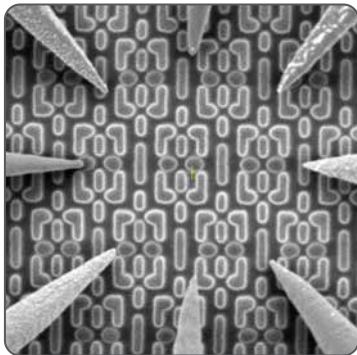

Thermo Scientific™ Hyperion™ II System



Atomic force probe based nanoprober for electrical fault localization and characterization in transistors and interconnects

- Fast fault localization
- Proven nanoprobng solution for 5 nm technology
- Low noise, high-resolution capacitance
- Fast transistor probing
- 7nm capable
- Conductive AFM and topographic AFM

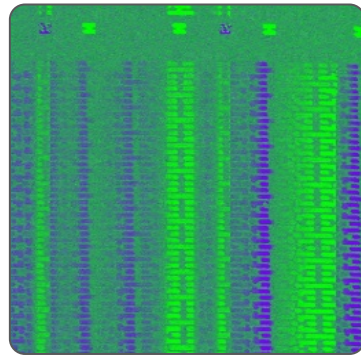

Preparation

Advanced physical and electrical analysis is required, across a broad range of device types and technology nodes, for yield management and process control. Precise, high-quality, efficient sample preparation is an increasingly important part of any analysis workflow and in most cases, the quality of the data depends on the quality of the sample preparation. Thermo Fisher Scientific provides industry standard sample preparation solutions based on its advanced focused ion beam (FIB) and beam chemistry techniques. These solutions are most commonly used for creating SEM cross-sections, TEM analysis, transistor nanoprobing and atom probe tomography preparation.

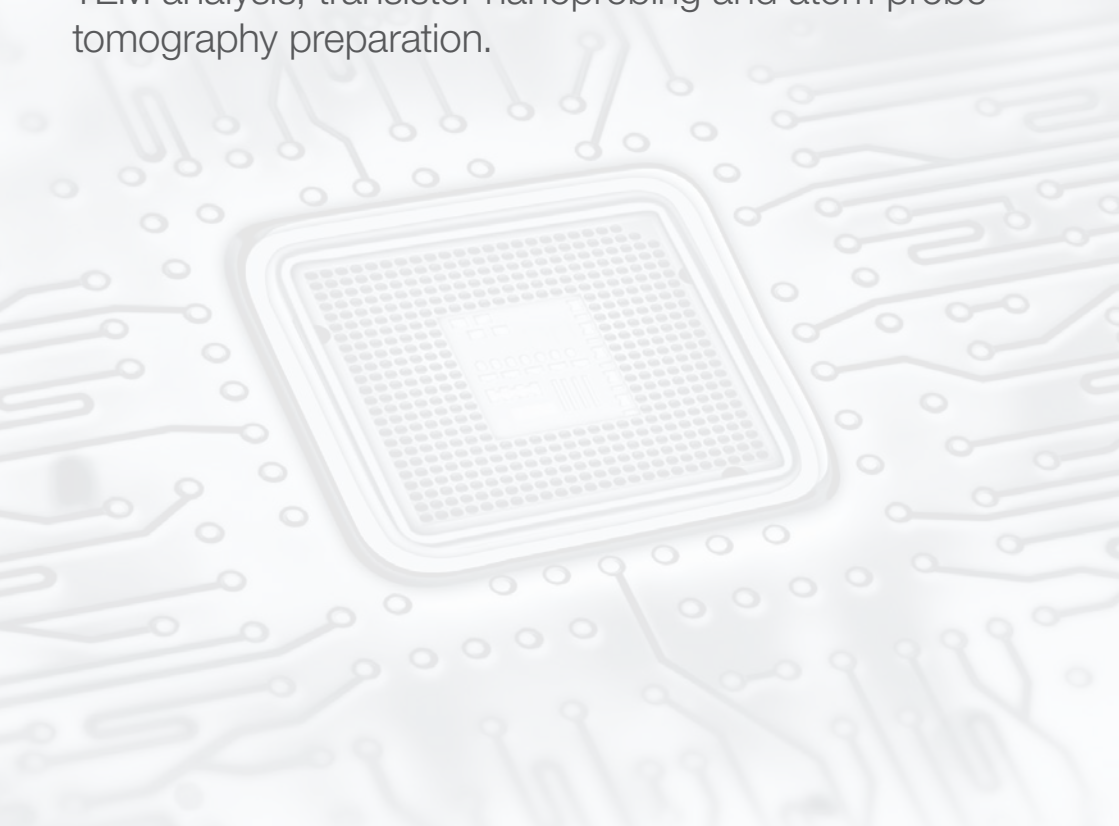

Preparation

Physical Analysis (*SEM, S/TEM, FIB Sample Prep*)

Thermo Scientific™ Helios™ 5 FX DualBeam



- Angstrom-scale STEM imaging and sample preparation
- Short time to nanoscale information
- Fast, accurate and precise milling and deposition of complex structures
- Automated TEM and Atom Probe sample preparation

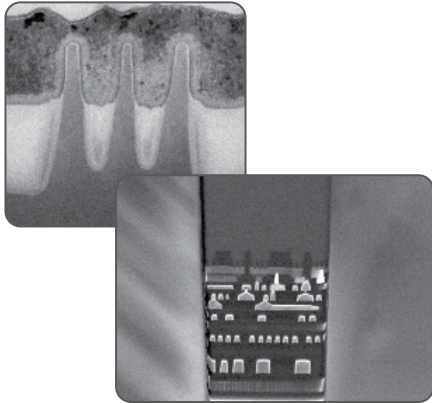

Top: High resolution *in situ* STEM image of a 14nm device cut across the fins of the device

Bottom: Low kV SEM image of a TEM lamella

Thermo Scientific™ Helios™ 5 HX DualBeam



- High-quality, ultra-thin TEM sample preparation enables analysis at the most advanced technology nodes
- Advanced 3D characterization and analysis at nanometer scale
- High-resolution with precise materials contrast
- High throughput and automated TEM sample preparation

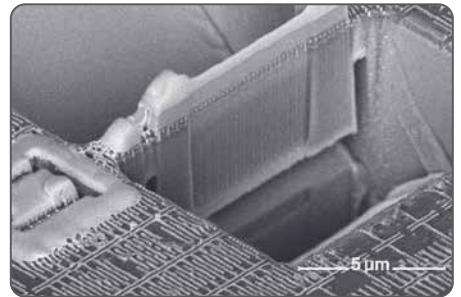

Thinned TEM lamella prior to lift-out

Preparation

Physical Analysis (*SEM, S/TEM, FIB Sample Prep*)

Thermo Scientific™ Helios™ 5 UC/UX/CX DualBeams



Highly configurable FIB/SEM DualBeam for a wide range of high-resolution semiconductor analysis applications

- Flexible stage and loadlock configurations
- 150mm/200mm wafer capable
- Suitable for logic, memory, advanced power, analog and MEM's device analysis
- Industry standard Helios TEM prep capability
- Automated “slice and view” and reconstruction software

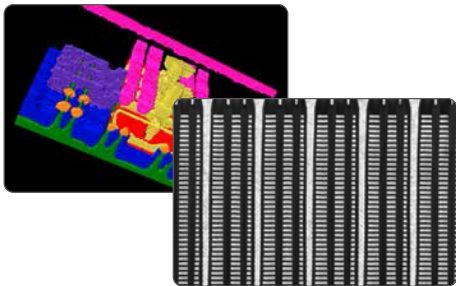

Top: 3D reconstruction of 14nm FinFET device produced with a Helios 5 and Avizo software
Bottom: Low voltage SEM cross section of 3D NAND device produced with a Helios 5 UX

Thermo Scientific™ Scios™ 2 DualBeam



- Full support of magnetic and non-conductive samples
- High throughput subsurface and 3D characterization
- Advanced ease of use and automation

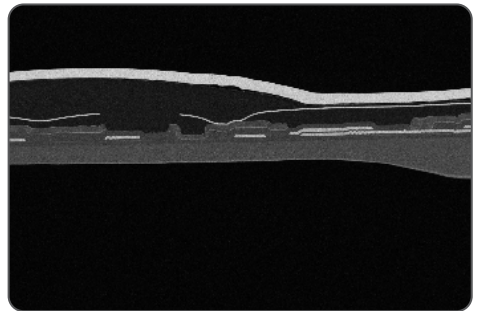

Backscattered electron image of an OLED in cross section

Preparation

Physical Analysis (*Large Area FIB Processing*)

Thermo Scientific™ Helios™ 5 PFIB HXe DualBeam



High throughput, planar/uniform large area deprocessing, sample preparation, and characterization of sub 7nm node logic and advanced memory devices.

- Automated large area deprocessing
- Sub-nanometer SEM imaging
- 4" Piezo UHR stage

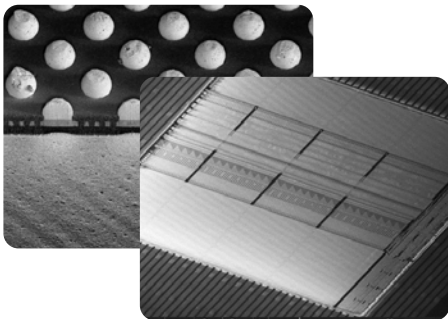

800um bulk large area cross-section of bumps and deprocessing of logic devices with Dx

Thermo Scientific™ Helios™ 5 PFIB UXe DualBeam



High throughput, uniform large area deprocessing and analysis for advanced node logic and 3D memory devices.

- Automated large area deprocessing
- Sub-nanometer SEM imaging
- 6" Piezo stage

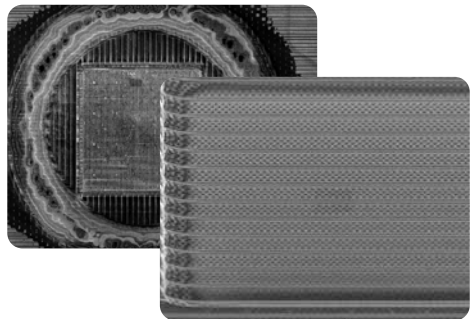

Bulk delayering of 3D NAND devices

Preparation

Physical Analysis (*Large Area FIB Processing*)

Thermo Scientific™ Helios™ 5 PFIB CXe DualBeam



High throughput, large area sample preparation and analysis of packaging materials and deprocessing of memory and logic devices

- Sub-nanometer, low energy SEM performance
- Cross section or plan view analysis
- Site-specific deprocessing and failure analysis

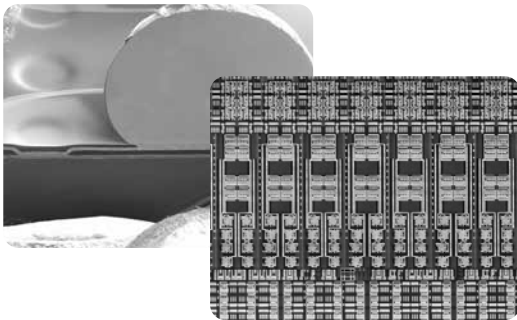

Cross-sections of large solder bump using diagonal mill (left) and close up view of layered region of interest for SEM inspection and nanoprobng applications

Preparation

Wafer Yield Control and Metrology

Thermo Scientific™ Helios™ 5 EX/L Wafer DualBeam



FIB-SEM TEM sample preparation for the semiconductor, enabling full-wafer analysis.

- Machine learning endpointing for precise cut placement
- Automated TEM sample preparation
- Low kV precision FIB milling

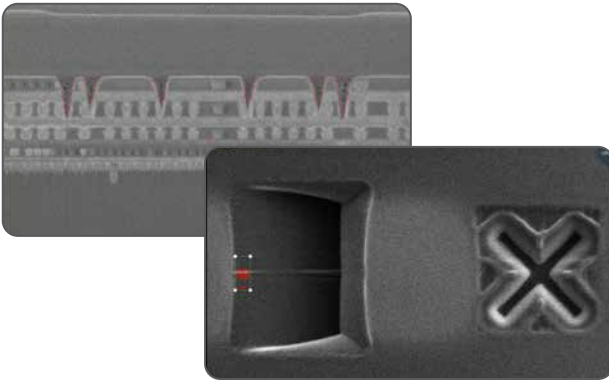

Site-specific TEM sample prep and fully automated end-pointing of ROI.

Analysis

Analytical solutions are the core of Thermo Fisher Scientific. We serve a broad range of semiconductor, microelectronics and academic markets with automated, high-productivity, high-performance tools. The semiconductor industry is one of the most demanding of these markets, with a growing need to maximize device performance, device yield, throughput and efficiency. Our analytical tools are the process of record for industry leading manufacturers of logic, memory, display, MEMS, analog and packaged devices. Additionally, they are seen as the reference technology in a wide variety of applications such as:

- Materials analysis
 - Device debug
 - Yield improvement
 - Defect/failure root-cause analysis
 - Metrology
 - Research and development
- 

Analysis

Physical Analysis (S/TEM)

Thermo Scientific™ Spectra™ Ultra TEM



Ultimate atomic answer for advanced semiconductor analysis and research

- Fast high tension switching to tailor voltage to experiment needs
- Lowest dose STEM EDX investigation of beam sensitive specimens
- Atomic scale analysis of the widest range of materials

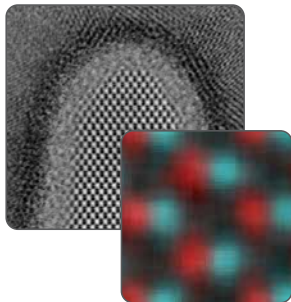

Atomic analysis of advanced logic devices

Thermo Scientific™ Spectra™ 300/200 TEM

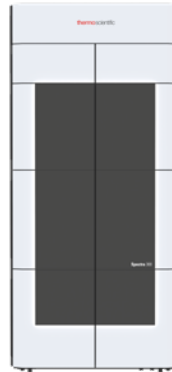

High resolution TEM and STEM for semiconductor applications

- High brightness X-CFEG
- Configuration flexibility

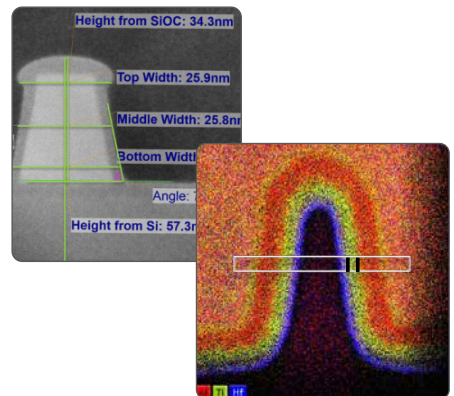

TEM image and EDS metrology.

Analysis

Physical Analysis (S/TEM)

Thermo Scientific™ Talos™ F200E (S)TEM



200 kV TEM and S/TEM for repeatable, high-volume analysis of a broad range of semiconductor and microelectronic devices,

- High-quality (S)TEM imaging with low distortion
- Precise, high-speed chemical characterization
- Dedicated semiconductor-related applications

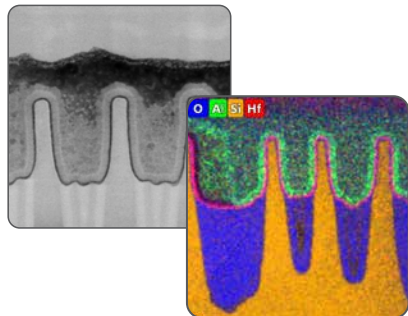

3D EDS tomogram of P-Zn-In nanotubes.

Thermo Scientific™ Metrios™ AX TEM



S/TEM for automated and manual workflows, metrology, and elemental analysis.

- AI driven, automated recipe generation
- Guaranteed imaging specifications
- Industry POR for high-volume reference metrology

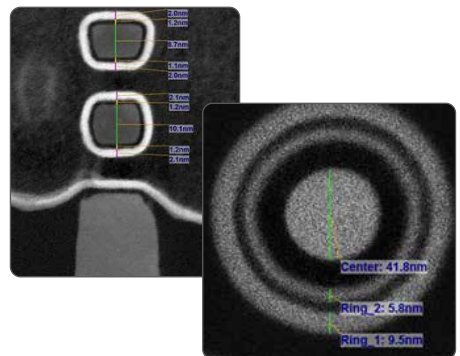

Automated metrology (top) and automated EDS using Thermo Scientific Dual-X detectors (bottom).

Analysis

Physical Analysis (SEM)

Thermo Scientific™ Verios™ 5 XHR SEM



Precise SEM characterization of nanomaterials with sub-nanometer resolution and high material contrast.

- Automate metrology applications
- Low dose operation and optimal contrast selection
- Sub-nanometer performance from 1-30kV

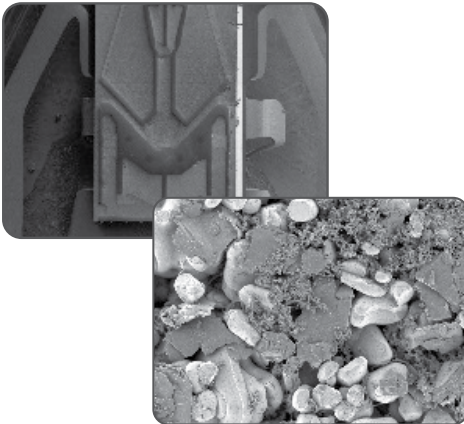

Low voltage images of ceramic battery catalyst and hard drive reader images.

Thermo Scientific™ Apreo™ 2 SEM System



High-performance for all-round nanometer or sub-nanometer resolution.

- Extreme flexibility for handling a wide sample type range
- Excellent performance at long working distance (10 mm)

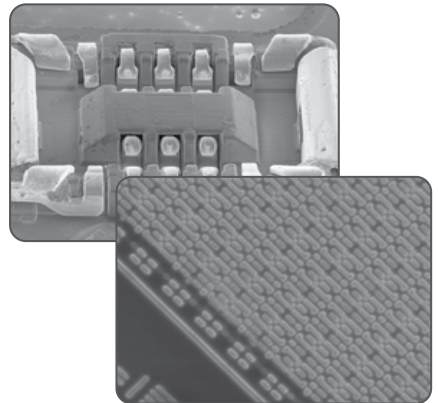

Top: Low voltage low magnification images of a component on a PCB
Bottom: 200V image of a deprocessed 14nm device.

Analysis

Physical Analysis (SEM)

Thermo Scientific™ Axia™ ChemiSEM



Flexible, easy to use and fast analytical SEM for general purpose surface analysis.

- Flexible sample loading for large, heavy samples (up to 10kg)
- Integrated, live (ChemiSEM) EDS
- Always fully optimized with auto alignments
- Simple UI with user guidance and undo functions

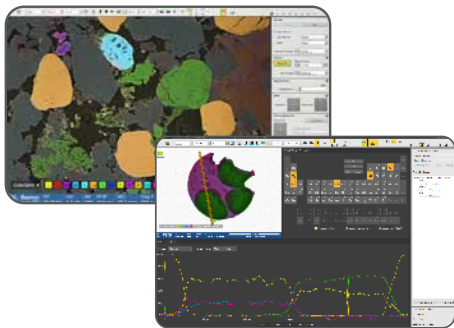

Live EDS imaging and simple user interface.

Thermo Scientific™ Phenom Desktop SEM



SEM product family for uncompromising performance in a desktop form factor.

- Available in a variety of configurations to suit various semiconductor applications such as particle analysis or device packaging analysis
- Resolutions of 2.5nm(SE) and <4.0nm (BSE) @ 15kV
- Up to 1,000,000x magnification
- Optional EDS configurations

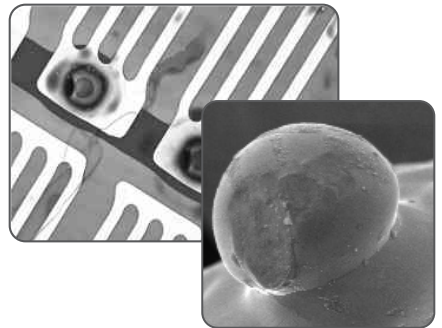

High resolution surface SEM analysis of packaged die and electronic modules.

Analysis

Surface Analysis (XPS)

Thermo Scientific™ K-Alpha™ X-ray Photoelectron Spectrometer (XPS) System

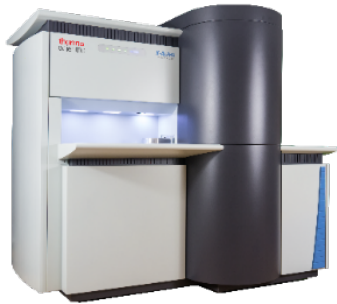

Fully automated XPS system with ion source for depth profiling.

Thermo Scientific Nexsa™ G2 X-Ray Photoelectron Spectrometer (XPS) System

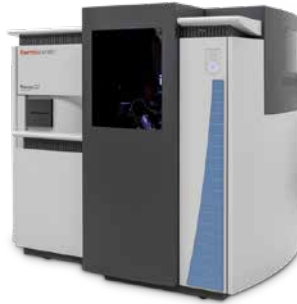

Multi-technique surface analysis system with micro-focus X-ray source. Options for cluster ion source, UV-photoelectron spectroscopy (UPS), ISS (LEIS), REELS.

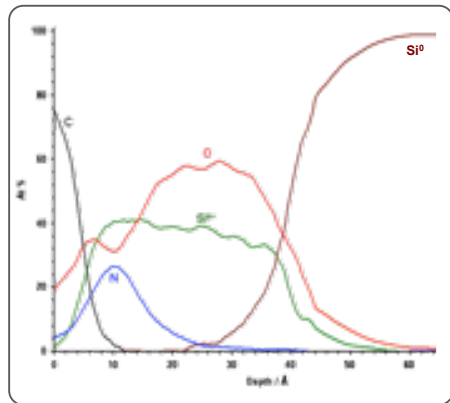

Understanding thin film structure and interface chemistry using the high performance ion source and high sensitivity spectrometer.

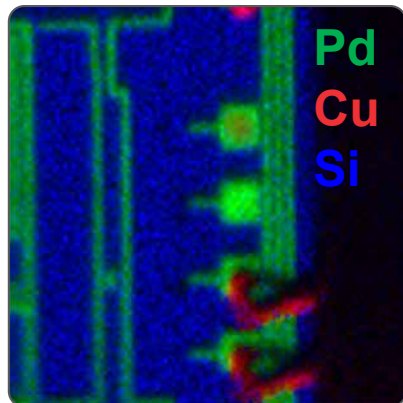

The small spot X-ray source enables identification of pad surface contamination, resist composition, and pad structure through depth profiling.

Analysis

Surface Analysis (XPS)

Thermo Scientific™ ESCALAB™ QXi System



Configurable surface analysis platform with options for UV-PS, Auger electron spectroscopy (AES), REELS, EDS and a range of sample preparation options.

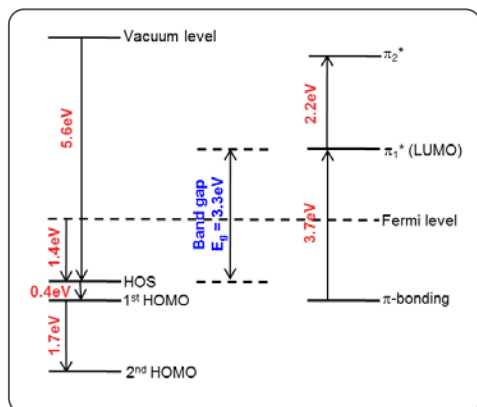

XPS, REELS and UVPS can be used together to understand work function and band gap properties

Analysis

Chemical Analysis (*RAMAN and FTIR*)

Thermo Scientific™ Nicolet™ iS50 FTIR Spectrometer



Reliable QC and characterization of
Epi, BPSG, C and O in Si wafers;
Quantitative analysis of semi-
conductor gases;

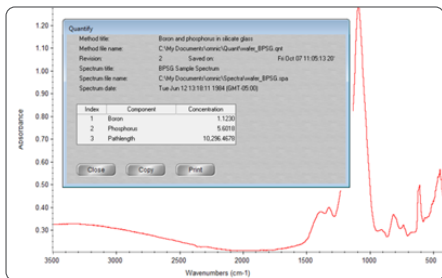

FTIR spectral analysis of BPSG film.

Thermo Scientific™ DXR™ 2xi Raman Imaging Microscope



Rapidly locate and identify organic and
inorganic contaminants on circuits, displays,
and sensors.

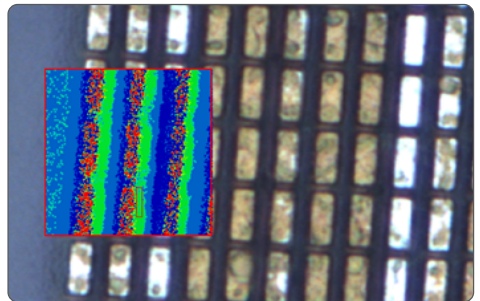

Raman principal component analysis of
strained regions in silicon.

Analysis

Chemical Analysis (*IC, ICP-MS, GC-MS*)

Thermo Scientific™ Dionex™ ICS 6000+ IC



- QA/QC of UPW and chemicals
- Anions cations contamination analysis

Thermo Scientific™ iCAP™ RQ ICP-MS, iCAP™ TQs ICP-MS



- QA/QC, UPW and semiconductor grade chemicals
- Ultratrace elemental impurities

Thermo Scientific™ ISQ™ GC-MS, Trace 1300 GC



- QA/QC of CR air and gases
- Organic contamination analysis

Thermo Scientific™ Element™ Series High-resolution ICP-MS



- QA/QC and research
- Interference free ultratrace impurities

Analysis

Wafer Yield Control and Metrology

Thermo Scientific™ Helios™ 5 EX/L Wafer DualBeam



FIB-SEM TEM sample preparation for the semiconductor, enabling full-wafer analysis

- Machine learning endpointing for precise cut placement
- Automated TEM sample preparation
- Low kV precision FIB milling

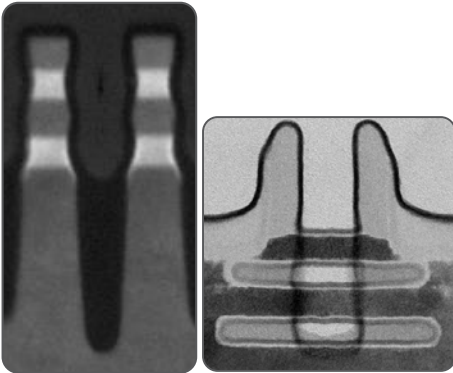

TEM of a Si/SiGe gate-all-around (GAA) fin (left), TEM along the nanowire of a GAA structure (right).

Thermo Scientific™ Helios™ 5 PXL Wafer DualBeam



PFIB SEM for in-line metrology and process monitoring of advanced 3D NAND, DRAM and high-aspect ratio devices

- Fast, precise, large-area wafer level deprocessing, diagonal milling and cross sectioning of high-aspect-ratio structures.
- Advanced automation capabilities identify potential issues, accelerating process development and minimizing manufacturing disruptions.
- High-resolution, high-contrast imaging for exact dimensional measurements of high-aspect-ratio 3D through-stack structures.

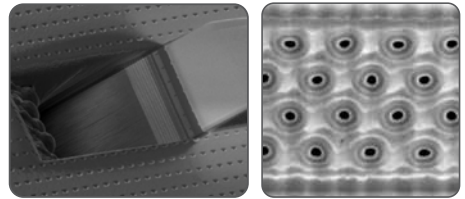

Wide-area diagonal mill of 3D NAND device (left) and SEM inspection of diagonal unfilled structures on same (right)

Analysis

Wafer Yield Control and Metrology

Thermo Scientific™ Metrios™ AX TEM



High productivity transmission electron microscope for semiconductor metrology and process characterization

- Automation options to support quality, consistency, metrology, and reduced OPEX
- Leverages machine learning for superior auto-functions and feature recognition
- Workflows for *in-situ* and *ex-situ* lamella preparation

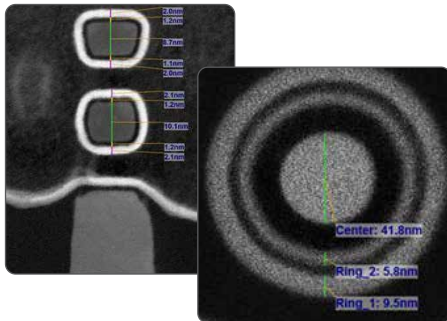

Automated metrology (top) and automated EDS using Thermo Scientific Dual-X detectors (bottom)

Analysis

ESD Compliance Testing

Thermo Scientific™ MK™ Series



Automated ESD testing to industry standards for human body model, machine model and latch-up.

- Rapid-relay-based operations
- Latch-Up stimulus and device biasing
- Easy-to-use operations



Thermo Scientific™ Orion3™ System



Charge device model discharge testing for simulating electrostatic discharge events

- Supports all popular test standards
- High resolution dual cameras
- Event detection and automatic waveform captures

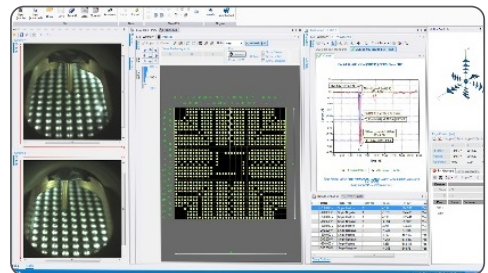

Analysis

ESD Compliance Testing

Thermo Scientific™ Celestron™ System



Transmission line pulse to characterize device protection structures and predict failures.

- Flexible TLP/VF-TLP Testing at the wafer and/or package level
- Unsurpassed test control

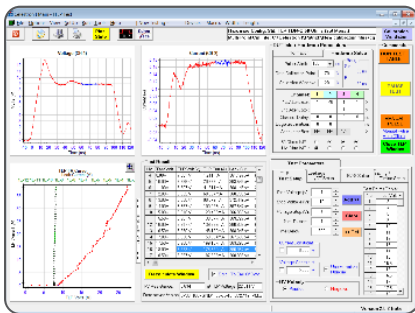

Intuitive software makes test setup and operation easy with the graphical user interface

Thermo Scientific™ Pegasus™ System



2 Pin ESD and curve tracing for wafers and packaged parts.

- Fully compliant industry standards Human Body Model (HBM) and Machine Model (MM) testing
- True system level ESD 150pF/330Ω network
- Pre- and post-curve trace measurements for comparative failure analysis

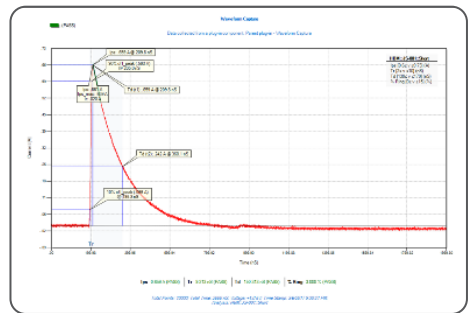

Precise 330 ohm waveform delivers results that correlate completely with ESD test standards

Analysis

Temperature Control

(Recirculating Chillers / Heat Exchangers)

Thermo Scientific™ ThermoFlex™ Chillers



- Highly configurable
- -5 to 90° C
- 900 to 24 kW Cooling
- Semi S2 compliant
- Etch
- Deposition

Thermo Scientific™ Merlin™ Chillers



- Fluorinert compatible
- -15 to 35° C
- 1.1 to 4.8 kW cooling
- Lithography
- Ion implant

Thermo Scientific™ ThermoChill™ Chillers



- Economical
- -10 to 30° C
- 0.7 to 2 kW cooling
- Lithography
- Ion implant
- Microscopy
- Spectrophotometry

Thermo Scientific™ Heat Exchangers



- Compact
- 5 to 40° C
- 14 to 100 kW cooling
- Microscopy
- Spectrophotometry

Thermo Scientific™ Custom Designs



- Special requirements
- -90 to 90° C
- Up to 100 kW cooling
- Up to $\pm 0.001^\circ$ C stability
- Test

Analysis

Circuit Edit

Thermo Scientific™ Centrios™ HX System



Highest precision circuit editing for advance technology node debug, repair and prototyping

- Cutting-edge performance for sub-7nm advanced semiconductor
- 25% higher resolution at 4X lower beam currents for unparalleled milling precision and control with low landing energy
- Innovative dual-nozzle gas-delivery system with the broadest portfolio of chemistries, enables industry leading high-precision etching and fast, efficient editing

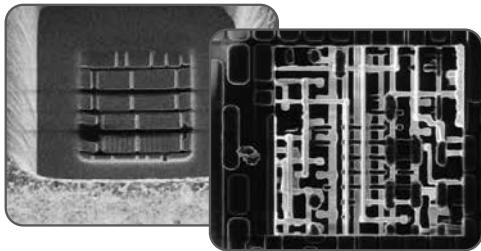

Featuring the new Thermo Scientific Celta Focused Ion Beam (FIB) Column, and providing ultimate control for performing edits accurately and with minimum circuit damage

Thermo Scientific™ Centrios™ CE System



Industry leading circuit editing for semiconductor debug, repair and prototyping

- Imaging and milling resolution to meet 14nm node applications
- Advanced front and backside edits with unparalleled editing control and precision.
- Planarity/uniformity, delayering/etch stopping and high-acuity drilling

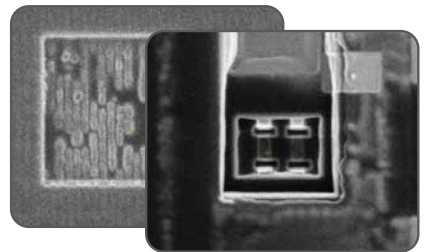

High resolution Tomahawk WDR FIB opens low-level metal layer with precision and control, while Dual Multichem design enables repeatable, precise and uniform process control

CAD Navigation

Workflows for physical failure analysis, electrical failure analysis, metrology and defect review all require continual improvements for enhanced productivity. Quickly and repeatably reaching the correct region of interest (ROI) is, therefore, essential. Thermo Scientific™ NEXS™ Software delivers a wide range of CAD-to-stage navigation capabilities for fault isolation, failure analysis, and sample preparation. It features easy-to-use CAD viewing and automatically drives the system stage to a precise ROI as indicated by the CAD model. Note that NEXS Software also reads the mask data from GDS2 and OASIS format files and provides connectivity options with other Thermo Scientific analytical tools.

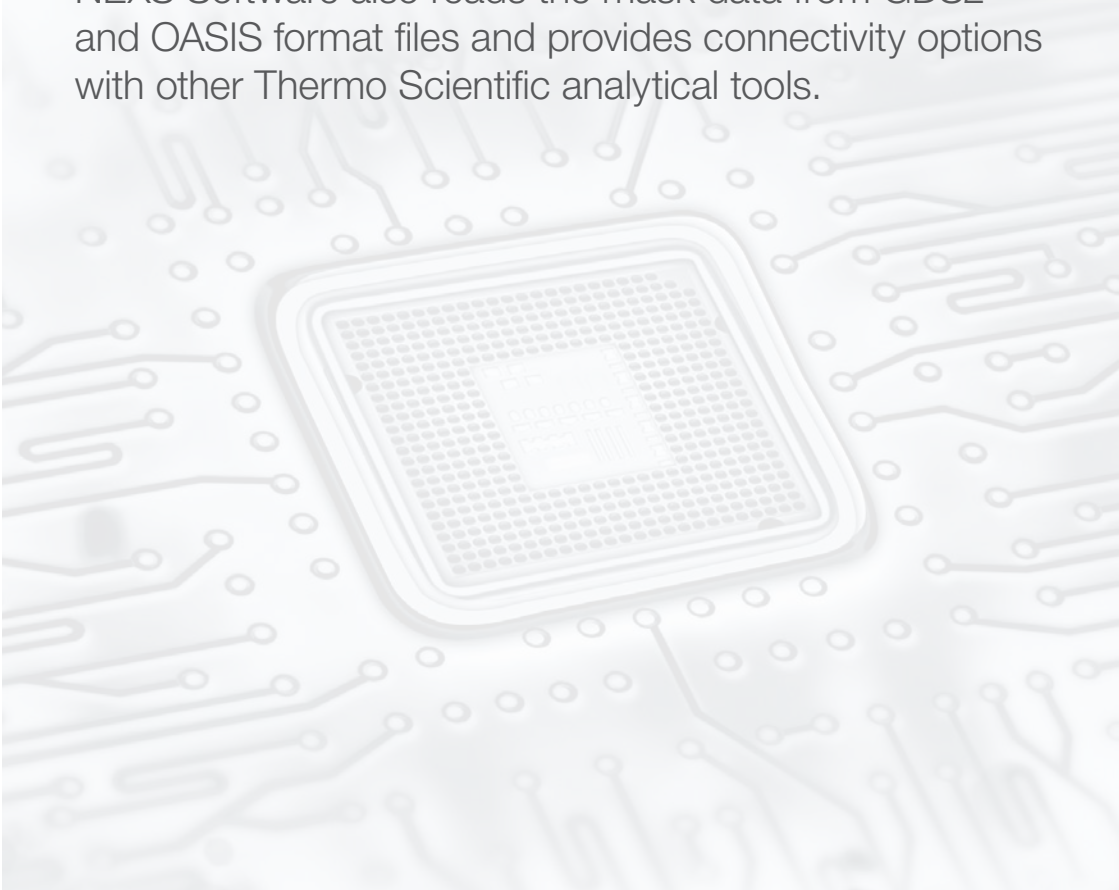

CAD Navigation

CAD-to-Stage Navigation Capabilities

NEXS CAD Navigation and Overlay



Provides user friendly navigation to CAD coordinates on all Thermo Scientific product platforms (CE, DualBeam Systems, Meridian, etc.)

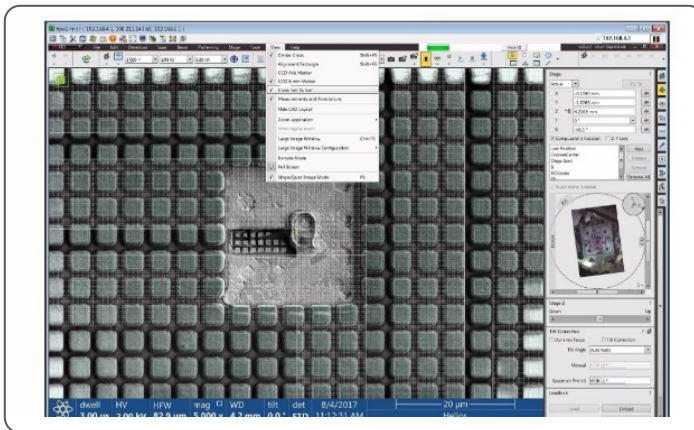

Simple navigation using CAD overlay on a Thermo Scientific Helios DualBeam image

Semiconductor Service Solutions

Integrated Service Solutions to Drive Your Business

Our technology-driven, expert care will help you:

- Increase system productivity
- Avoid unplanned downtime
- Upskill and empower users
- Improve fleet performance

Our Classic Care services keep your system in peak condition with the latest software updates, expert telephone support, RAPID remote diagnostics, and regular preventative maintenance.

Our Accelerate and Advance portfolios transform service with a data-driven approach so you can proactively plan services activities and align your fleet for optimal operations. The Connected Care Portal will keep data at your fingertips so you can monitor system utilization and trends.

Service Offering	Warranty	Classic Contracts	Accelerate & Advance Contracts
Phone support	•	•	•
Preventive Maintenance	•	•	•
Software updates	•	•	•
Parts	•	•	•
RAPID Connection	•	•	•
On-site response time	48 hours	4-72 hours	4-48 hours
Connected Care Portal			•
System Remote Monitoring			•
Uptime guarantee			•
After hours on-site service			•
Regular account reviews			•
Fleet compare			•

Specific service offerings vary across contracts and geographies.

Perform Services

Productivity and System Performance

Our Perform offerings (part of our Classic Services) are comprehensive in critical system support - boosting performance, minimizing downtime and consistent business outcomes.

- Quick connection to system experts via the web, email or phone for troubleshooting and system inquiries
- Keep systems in peak condition with the latest software updates, including license and installation
- Get Thermo Scientific quality parts expedited on-site from strategic global inventories
- Ensure a rapid response with priority access to Thermo Fisher engineers
- Experience optimum system function with regular preventive maintenance

In addition to our technical experts, software updates and access to RAPID remote service and telephone support, our Perform service options offer a wide range of features that provide the support you need to deliver exceptional results.

	Perform Pro	Perform Assure	Perform Complete	Perform Enhanced	Perform Edge	Perform Ultimate
On-site response	72-hour	48-hour	48-hour	24-hour	4-hour	4-hour + weekend on-call coverage
Parts	15% discount	15% discount CM parts	•	•	•	•
Consumables	PM Consumables only		Optional	Optional	Optional	Optional
Extended FSE hours				•	•	•
Account reviews				Semi-annual	Monthly	Weekly
Local parts stocking					Optional	Optional
Targeted system uptime					•	
Guaranteed system uptime						•

Accelerate & Advance Services

Transforming service with a data-driven approach

As a part of the competitive semiconductor and electronics industry, you need to be able to rely on your equipment to meet the ongoing need for uptime and results to support your company's aggressive goals.

With Accelerate and Advance Services, we offer an end-to-end solution that integrates convenient access to data, continuous system remote monitoring, the support of a Customer Success Manager, and the comprehensive on-site maintenance you are accustomed to.

Customers with Accelerate and Advance experience up to 10% fewer unplanned downtime hours.

Remote System Monitoring

- Critical parameters are monitored
- Proactive service engagement if anomalies are detected

Connected Care Portal

- System utilization and trends
- Average uptime and trends
- Fleet Compare
- Digital Reporting

Optimize System Performance

- Guaranteed uptime
- Reduce unplanned downtime
- After hours service support

Maximize Productivity

- Customer Success Manager to drive customer objectives via entitlements
- Applications support that focus on system reliability and consistency

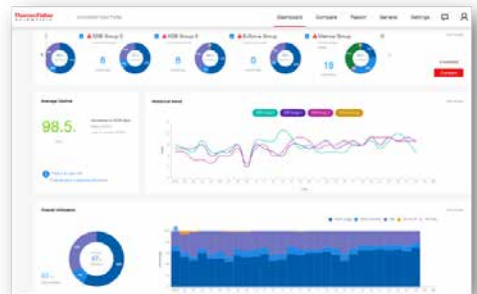

Automated Workflows

Near Line Metrology

Calibrated and distortion-free imaging is essential for precise and accurate metrology, enabling fabrication engineers to make mission critical process decisions. The ability to produce large amounts of quality automated data is fundamental to understanding how 2D and 3D structures evolve from the front to back end of the line. This data is equally important as reference metrology for optical critical dimension (OCD) models. Automated imaging and metrology enable fast, consistent and precise data at a fraction of the operator overhead. Our enhanced throughput model ((H)ETM) workflows are engineered for industry leading productivity and fastest time-to-data and are the process of record across the semiconductor world.

Root-cause Analysis

The management and elimination of defects during fabrication is becoming more and more challenging as they become smaller and buried in relatively large 3D structures. Thermo Fisher Scientific is the leading provider of workflow solutions to locate, isolate and study defects on a broad range of device types and scale lengths. We have developed high-yield, high-productivity solutions that can work from the millimeter to atomic scale and provide the most comprehensive chemical, structural and physical information, all with the fastest time-to-data available.

Automated Workflows

SEM and TEM Metrology

3D SEM Metrology

Helios 5 PXL

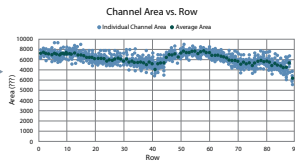
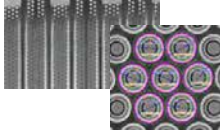

FIB milling/delaying and SEM imaging on 3D buried structures

Automated SEM metrology

Inline wafer return

S/TEM Metrology

Helios 5 EXL

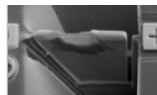

Sample preparation

Metrios AX S/TEM

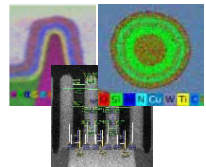

S/TEM characterization and automated metrology

Automated Workflows

Root-cause Analysis



Helios Plasma FIB

Precise, damage-free,
site-specific device delayering
and cross-section imaging



nProber Nanoprobing

Simple, reliable fault isolation
and transistor characterization
at the nanometer scale



Helios FIB/SEM

High productivity, tools for
cross-section imaging and analysis,
the most trusted tools for TEM
and Atom Probe sample preparation;
available in small sample

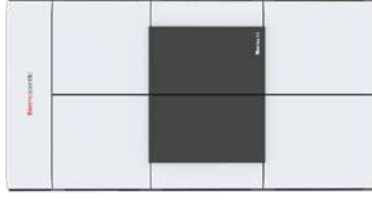

Metrios/Spectra/Talos TEM

Fastest time to data on TEM
platforms that can be configured
for a variety of defect analysis
applications (for example S/TEM
imaging, EDS, EELS, strain)

EFA to PFA Workflows

Example: FA on Power MOSFET Devices

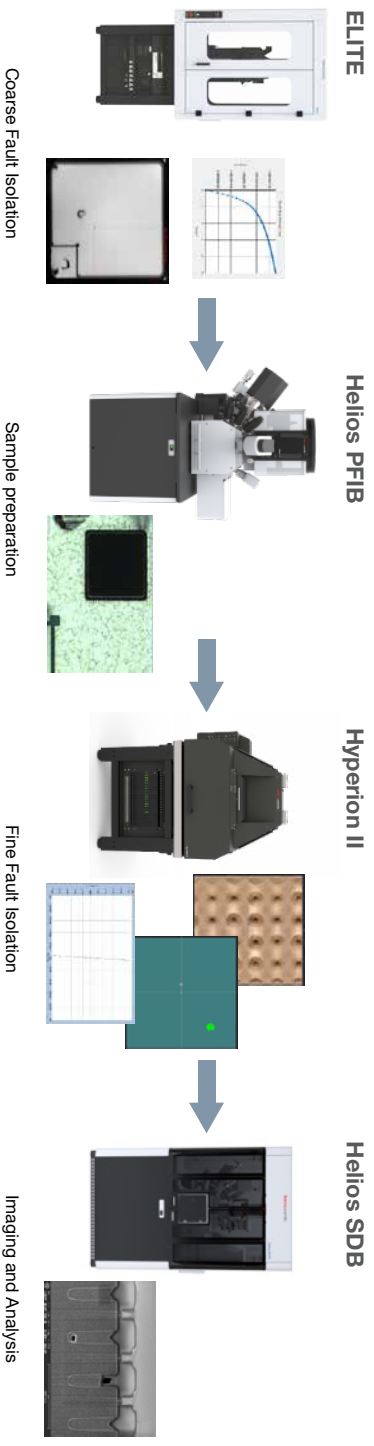

Precision sample preparation + high accuracy fault localization = high performance, high success-rate PFA

Product Table

Thermo Scientific Systems

Thermo Scientific™	Page #	Localization			Preparation						Analysis						
		Thermal Fault Isolation	Optical Fault Isolation	Nanoprobing	Laser In Situ Cross Sectioning	Delayering	Cross-Sectioning	S/TEM	Atom Probe Preparation	Circuit Edit	S/TEM & SEM	Metrology	Elemental Analysis	Defect Analysis	Chemical Analysis	Surface Analysis	ESD Testing
Elite™ System	6	■															
Meridian™ System	6		■														
nProber™ System	7			■													
Hyperion™ II System	7			■													
Helios™ 5 FX DualBeam	9					■		■		■		■	■				
Helios™ 5 CX/UX/HX DualBeam	9, 10					■				■		■	■				
Scios™ 2 DualBeam	10					■				■		■	■				
Helios™ PFIB CXe/UXe/HXe DualBeam	11, 12				■	■				■		■	■				
Helios™ 5 EX/L Wafer DualBeam	13, 23					■				■		■	■				
Helios™ 5 PXL Wafer DualBeam	23				■	■					■		■				
Talos™ S/TEM	16						■					■	■				
Spectra™ S/TEM	15						■					■	■				
Spectra™ Ultra S/TEM	15						■				■	■	■				
Metrios™ AX S/TEM	16, 24						■				■	■	■				
Verios™ 5 XHR	17									■	■	■	■			■	
Phenom Desktop SEM	18									■		■	■			■	
Axia ChemiSEM	18									■		■	■			■	
Apreo™ 2 System	17									■		■	■			■	
MK Series ESD & Latch-Up Test System	25																■
Orion™ 3 System	25																■
Celestron™ System	26																■
Pegasus™ System	26																■
Centrios™ HX System	28								■								
Centrios™ CE System	28								■								
K-Alpha™ XPS System	19											■			■		
Nexsa™ 2 XPS System	19											■			■		
ESCALAB™ Xi+ System	20											■			■		
Nicolet™ iS50 FTIR Spectrometer	21														■		
DXR™ 2xi Raman Imaging Microscope	21														■		
Dionex™ ICS 6000+ IC	22														■		
iCAP™ RQ ICP-MS/TQs ICP-MS	22														■		
iSQ™ GC-MS, trace 1300 GC	22														■		
Element Series High-resolution ICP-MS	22														■		

Further Reading

Papers/presentations

Electron Channeling Contrast Imaging (ECCI) for beyond Silicon materials characterization

Mr. Libor Strakos, Thermo Fisher Scientific, Brno, Czech Republic
Andreas Schulze, PhD, Imec, Leuven, Belgium
Mr. Ondrej Machek, Thermo Fisher Scientific, Brno, Czech Republic
Tomas Vystavel, PhD, Thermo Fisher Scientific, Brno, Czech Republic
Mr. Matty Caymax, Imec, Leuven, Belgium
Richard J. Young, PhD, Thermo Fisher Scientific, Hillsboro, OR

Automated Diagonal Slice & View Solution for 3D Device Structure Analysis

Sang Hoon Lee, PhD, Thermo Fisher Scientific, Hillsboro, OR
Mr. Jeff Blackwood, Thermo Fisher Scientific, Hillsboro, OR
Mr. Stacey Stone, Thermo Fisher Scientific, Hillsboro, OR
Michael Schmidt, Thermo Fisher Scientific, Hillsboro, OR
Mark Williamson, PhD, Thermo Fisher Scientific, Hillsboro, OR
Woo Jun Kwon, Thermo Fisher Scientific Korea, Suwon-si, Gyeonggi-do, Korea, Republic of (South)
Sung Jae Lee, Thermo Fisher Scientific Korea, Suwon-si, Gyeonggi-do, Korea, Republic of (South)

Improved Phase Data Acquisition for Thermal Emissions Analysis of 2.5D IC

Ms. Bernice Zee, Advanced Micro Devices (AMD), Singapore, Singapore
Ms. Wen Qiu, Advanced Micro Devices, Singapore, Singapore
Brian Lai, Thermo Fisher Scientific, Fremont, CA
David Tien, Thermo Fisher Scientific, Fremont, CA
Jim Vickers, Thermo Fisher Scientific, Fremont, CA

Analysis of induced end-of-life failures in SRAM through nanoprobeing

Mr. Oberon St John Dixon-Luinenburg, Thermo Fisher Scientific, Santa Barbara, CA
Mr. Jordan Fine, PhD, Thermo Fisher Scientific, Santa Barbara, CA

Novel Approach of Improving Secondary Electron Detector in FIB System

Steve Wang, PhD, Thermo Fisher Scientific, Fremont, CA
Jim McGinn, Thermo Fisher Scientific, Fremont, CA
Peter Tvarozek, Thermo Fisher Scientific, Fremont, CA
Mr. Amir Weiss, Thermo Fisher Scientific, Fremont, CA

High Resolution Image Fusion of Linearly Polarized Subsurface Optical Images

T. Berkin Cilingiroglu, Thermo Fisher Scientific
Neel Leslie, Thermo Fisher Scientific
Seema Somani, Thermo Fisher Scientific
Prasad Sabbineni, Thermo Fisher Scientific

Use of analog simulation in failure analysis: Application to Emission microscopy and laser Voltage Probing techniques

Mr. Etienne Auvray, ST Microelectronics, Grenoble Cedex, France
Mr. Paul Armagnat, ST microelectronics, GRENoble, France
Dr. Luc Saury, ST microelectronics, GRENoble, France
Dr. Antoine Reverdy, IMS laboratory, University of Bordeaux, Talence, France
Mr. Tommaso Melis, ST microelectronics, GRENoble, France

Partner with us —

The process of record for major semiconductor manufacturers, equipment makers and service labs around the world

 Learn more at thermofisher.com/EM-semiconductors

For research use only. Not for use in diagnostic procedures.
For current certifications, visit thermofisher.com/certifications

© 2022 Thermo Fisher Scientific Inc. All rights reserved. All trademarks are the property of Thermo Fisher Scientific and its subsidiaries unless otherwise specified. BR0086-EN-06-2022